

AC15 Variable Speed Drive

IP20 Compact Drive for Motor Control in
General Purpose Applications 0.37 - 30 kW

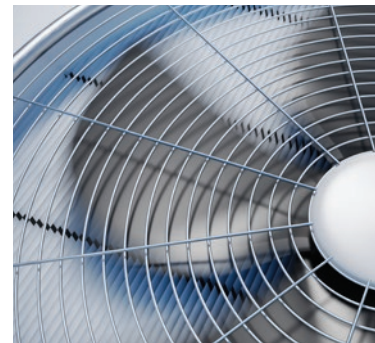

ENGINEERING YOUR SUCCESS.



WARNING – USER RESPONSIBILITY

FAILURE OR IMPROPER SELECTION OR IMPROPER USE OF THE PRODUCTS DESCRIBED HEREIN OR RELATED ITEMS CAN CAUSE DEATH, PERSONAL INJURY AND PROPERTY DAMAGE.

- This document and other information from Parker-Hannifin Corporation, its subsidiaries and authorized distributors provide product or system options for further investigation by users having technical expertise.
- The user, through its own analysis and testing, is solely responsible for making the final selection of the system and components and assuring that all performance, endurance, maintenance, safety and warning requirements of the application are met. The user must analyze all aspects of the application, follow applicable industry standards, and follow the information concerning the product in the current product catalog and in any other materials provided from Parker or its subsidiaries or authorized distributors.
- To the extent that Parker or its subsidiaries or authorized distributors provide component or system options based upon data or specifications provided by the user, the user is responsible for determining that such data and specifications are suitable and sufficient for all applications and reasonably foreseeable uses of the components or systems.

Overview	5
Features	6
Technical Characteristics	8
Power Ratings	8
Electrical Characteristics.....	9
Environmental Characteristics	9
Standards and Compliance	9
Dimensions [mm].....	10
Power Connections.....	11
Control Connections	12
Software.....	13
Parker Drive System Explorer (DSE Lite)	13
Accessories and Options	14
6901 Remote Mounting Keypad	14
Cable Screening Bracket	14
Braking Resistor	15
EMC Filter	15
Order Code	16

Variable Speed Drive - AC15 Series

Overview

Description

The AC15 Compact Drive is a simple to use, reliable and economical solution for every-day motor control applications that require speed or torque control in the power range of 0.37 kW to 30 kW. With compact dimensions and features normally only associated with higher specification drives, including Safe Torque Off, Ethernet communications, sensorless vector mode for control of both Permanent Magnet (PMA) and AC induction motors and a full 150 % overload for 1 minute, AC15 provides an optimized solution for OEM machine builders looking for a compact, cost-effective drive without compromising on performance.

Simplicity

AC15 is designed to reduce the time and effort required to install, setup and commission through it's easy to use integrated keypad and application macros, or the powerful DSE Lite tool and rich function block set. Minimal wiring requirements and easily accessed terminals make AC15 quick and easy to install. Auto-tuning sensorless vector mode takes AC15 beyond simple V/Hz control allowing users requiring greater dynamic speed or torque control for their application to benefit from the drive's enhanced speed and torque accuracy.

Reliability

Proven technology and manufacturing techniques ensure AC15 has been engineered and built to deliver consistently outstanding levels of performance day in, day out, ensuring maximum uptime and productivity. Thanks to its conformally coated PCBs, AC15 is capable of withstanding class C3 environments, allowing you to operate AC15 with the utmost confidence in more applications.



Technical Characteristics - Overview

Power Supply	220 ... 240 VAC ±10 % Single Phase 220 ... 240 VAC ±10 % Three Phase 380 ... 480 VAC ±10 % Three Phase
Input Frequency	50/60 Hz ±10 %
Power Range	0.37...30 kW Heavy Duty (HD)
Overload	150% for 60 sec.
Output Frequency	0.5 - 590 Hz
Safe Torque Off (STO)	SIL2, PLd
Operating Temperature	0...40 °C (derate up to max 45°C)*
Altitude	0-1000m (derate up to 2000m)

* Temperature derate not available on 0.37kW 230V version

Features

AC15 Series Drive

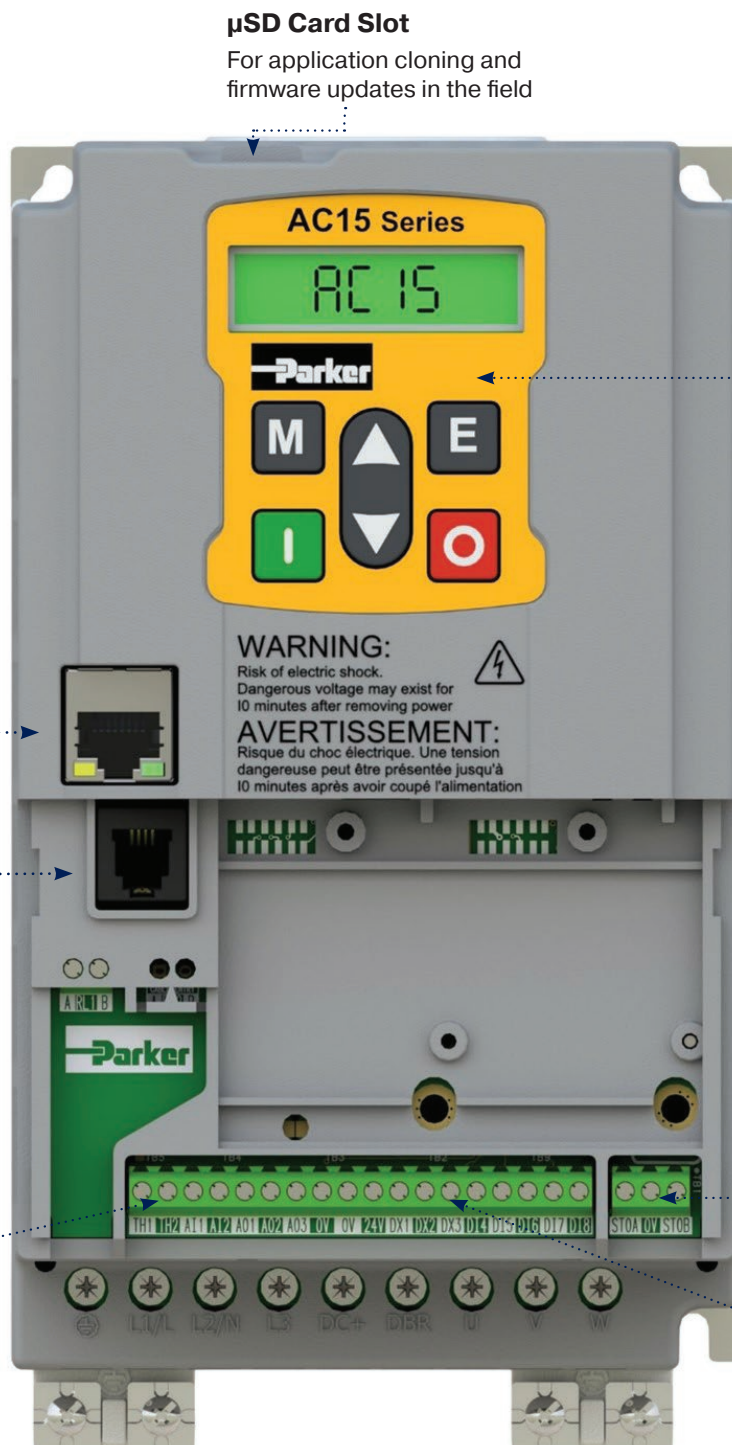

µSD Card Slot

For application cloning and firmware updates in the field

Built-in Display Keypad

Operate the drive and see real time diagnostic feedback through the backlit built-in display

Built-in Ethernet Comms

Modbus TCP/IP as standard. Access the drive webpage or program the drive through the popular and intuitive DSELite configuration tool

Built-in Safe Torque Off

Independently certified STO to SIL2, PLd as standard. Complies to:

- EN ISO13849-1:2015
- EN 61800-5-2:2017
- EN 61508

6901 Keypad Support:

Connect an optional remote 6901 keypad to the RJ11 port.

Built-in Motor Thermistor Input

PTC Motor Thermistor feedback connection as standard

User I/O

Exceptional quantity of configurable analogue and digital I/O for maximum application flexibility

Standards & Compliance

The product is certified to the latest international standards:

Europe:

- Low Voltage Directive 2014/30/EU
- Electro-Magnetic Compatibility Directive 2006/42/EC
- EN61800-5-1:2017+A11:2021
- EN61800-3:2018
- IE 2 Compliant

North America & Canada:

- UL61800-5-1
- CSA22.2#274-17

Applications

AC15 provides a no-fuss approach to general purpose industrial motor control applications across a wide range of industries, giving users the benefits of the inherent energy-saving properties of using a variable speed drive, as well as the improved reliability and extended service life benefits associated with smoother starting and stopping of regularly cycling loads.

Typical applications for AC15 include...

- **Conveyor**
- **Centrifuge**
- **Fans**
- **Mixers**
- **Packaging Machines**
- **Textile Machines**
- **Strapping Machines**
- **Labelling Machines**
- **Industrial Washing Machines**
- **Machine Tool Spindles**
- **Roller Doors**



Conveyors

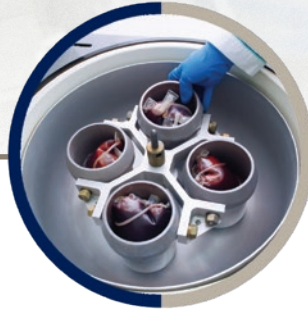

Centrifuges



Fans



Mixers

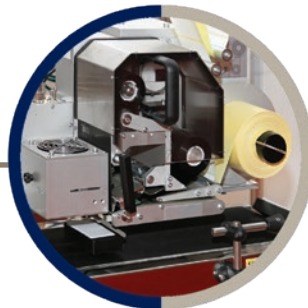

Packaging Machines

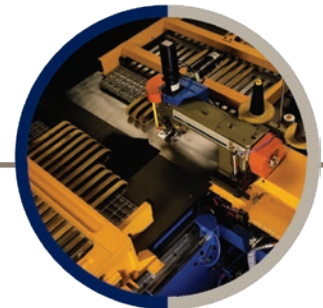

Textile Machines

Technical Characteristics

Power Ratings

220-240 VAC, Single Phase Supply Voltage				
Order Code	Input Current [A]	Output Current [A]	HD Power Rating [kW]	Frame Size
15G-11-0025-BF	5.8	2.5	0.37	1
15G-11-0045-BF	10	4.5	0.75	
15G-11-0070-BF	14	7	1.5	
15G-12-0100-BF	20	10	2.2	2

220-240 VAC, Three Phase Supply Voltage				
Order Code	Input Current [A]	Output Current [A]	HD Power Rating [kW]	Frame Size
15G-31-0025-BF	3.5	2.5	0.37	1
15G-31-0045-BF	5.4	4.5	0.75	
15G-31-0070-BF	7.8	7	1.5	
15G-32-0100-BF	11	10	2.2	2
15G-33-0170-BF	18.5	17	4	3
15G-34-0210-BF	22	21	5.5	4
15G-35-0300-BF	31	30	7.5	5
15G-35-0400-BF	41	40	11	

380-480 VAC, Three Phase Supply Voltage				
Order Code	Input Current [A]	Output Current [A]	HD Power Rating [kW]	Frame Size
15G-41-0012-BF	1.5	1.2	0.37	1
15G-41-0020-BF	3	2	0.75	
15G-41-0040-BF	5	4	1.5	
15G-42-0065-BF	7.5	6.5	2.2	2
15G-42-0090-BF	11	9	4	
15G-43-0120-BF	14	12	5.5	3
15G-43-0170-BF	18.5	17	7.5	
15G-44-0230-BF	24	23	11	4
15G-44-0320-BF	36.5	32	15	
15G-45-0380-BF	44	38	18.5	5
15G-45-0440-BF	51	44	22	
15G-45-0600-BF	70	60	30	

Electrical Characteristics

Power Supply	220 ... 240 VAC ±10 % Single Phase 220 ... 240 VAC ±10 % Three Phase 380 ... 480 VAC ±10 % Three Phase
Input Frequency	50/60 Hz ±10 %
Power Range	0.37...30 kW Heavy Duty (HD)
Overload	150% for 60 sec.
Output Frequency	0.5...590 Hz
Max. Switching Frequency	10 kHz
Control Modes	Volts/Hertz or Sensorless Vector (SLV) modes
Supported Motors	Induction & PMAC

Environmental Characteristics

Temperature range	0-40 °C (derate up to max. 45 °C)*
Humidity	Up to 90 % Relative Humidity, non-condensing
Vibration	< 0.5 g
Altitude	0-1000 m (derate 1% per 100m up to max. 2000m)
Protection Degree	IP20
Pollution Degree	Category 2
Chemically Active Substances	Compliance with EN60271-3-3: C3

* Temperature derate not available on 0.37kW 230V version

Standards and Compliance

Europe	This product conforms with: - Low Voltage Directive 2014/30/EU - Electro-Magnetic Compatibility Directive 2006/42/EC - EN61800-5-1:2007+A11:2021 - EN61800-3:2018
North America / Canada	Complies with the requirements of: - UL61800-5-1 - CSA22.2#274-17 as an open-type drive
STO	Independently certified to: - EN ISO13849-1:2015 - EN 61800-5-2:2017 - EN 61508
RoHS	This product complies with the RoHS substance restrictions in accordance with EC Directive 2011/65/EU
REACH	This product complies with the REACH regulations EC1907/2006

Dimensions [mm]

AC15 Series				
Frame	Height (H)	Width (W)	Depth (D)	Weight [kg]
1	138.0	81.5	144.3	1.1
2	180.0	108.4	185.0	2.0
3	237.5	141.6	184.0	3.3
4	265.0	161.0	196.0	4.4
5	340.0	210.0	220.2	8.0

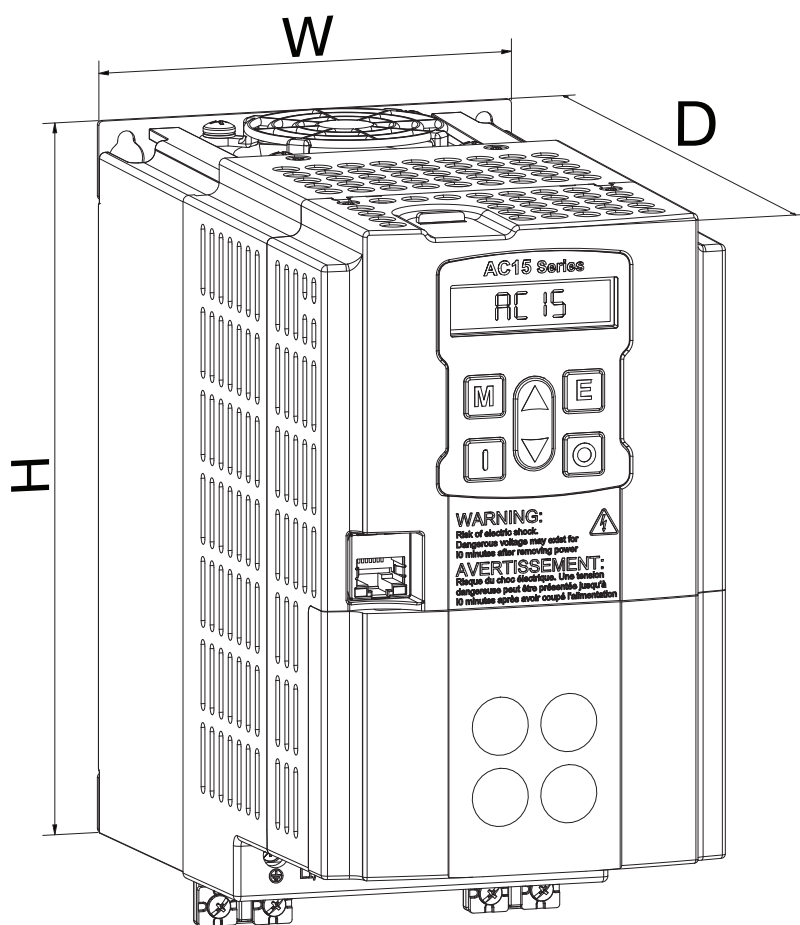

Power Connections

Frame 1

Terminal	Description
L3 / PE	Supply Input phase L3 / Earth
L2 / N	Supply Input phase L2 / Neutral
L1 / L	Supply Input phase L1 / Live
DC+	Dynamic Brake Resistor connection (+)
DBR	Dynamic Brake Resistor connection (-)
U	Motor Output phase U
V	Motor Output phase V
W	Motor Output phase W

Frame 2-4

Terminal	Description
PE	Earth
L1 / L	Supply Input phase L1 / Live
L2 / N	Supply Input phase L2 / Neutral
L3	Supply Input phase L3
DC+	Dynamic Brake Resistor connection (+)
DBR	Dynamic Brake Resistor connection (-)
U	Motor Output phase U
V	Motor Output phase V
W	Motor Output phase W

Frame 5

Terminal	Description
PE	Earth
L1	Supply Input phase L1
L2	Supply Input phase L2
L3	Supply Input phase L3
DC+	DC+ / Dynamic Brake Resistor connection (+)
DC-	DC-
DBR	Dynamic Brake Resistor connection (-)
U	Motor Output phase U
V	Motor Output phase V
W	Motor Output phase W



Control Connections

Label	Description
RLY1A	RelayOutput 1 (Contact A)
RLY1B	RelayOutput 1 (Contact B)
TH1	Motor Thermistor Input
TH2	Motor Thermistor Input
AIN1	Analogue Input 1 ($\pm 10V^*$, 0-10V, 0-20mA, 4-20mA)
AIN2	Analogue Input 2 ($\pm 10V^*$, 0-10V, 0-20mA, 4-20mA)
AOUT1	Analogue Output 1 (0-10V, 0-20mA)
AOUT2	Analogue Output 2 (0-10V, 0-20mA)
AOUT3*	Analogue Output 3 ($\pm 10V$, 0-10V)
0V	0V reference for analogue & digital I/O
0V	0V reference for analogue & digital I/O
24V	24V user supply
DIO1	Digital Input / Output 1 (24V configurable)
DIO2	Digital Input / Output 2 (24V configurable)
DIN3	Digital Input 3
DIN4	Digital Input 4 (High speed capable)
DIN5	Digital Input 5 (High speed capable)
DIN6	Digital Input 6
DIN7*	Digital Input 7
DIN8*	Digital Input 8
STO1	STO input channel A
STO0V	STO 0V reference
STO2	STO input channel B

* = Frames 2-5 only



Software

Parker Drive System Explorer (DSE Lite)

Parker drive configuration software Drive System Explorer (DSE) Lite is an easy to use drive configuration software package, designed to make programming your application as simple as possible without compromising on functionality.

DSE Lite is based around straightforward block programming and an intuitive user interface which supports user-defined configurations and offers real-time monitoring and charting. DSE Lite allows the user to create, parameterize and configure user defined applications as well as parameterize and connect fixed Motor Control blocks with up to 100 'links'

Thanks to the on-line help and pre-configured macro templates, users can achieve the optimum drive configuration without the need to navigate through complicated parameter menus.

DSE Lite for AC15 uses a standard Ethernet connection between PC and inverter, so no special lead is required.

Enhanced features of the AC15 include:

- High speed Ethernet connectivity
- Network scan feature
- Drive network identification
- Firmware installs over Ethernet
- Save a project to on-board Flash memory
- Compatibility with the AC30 Series PDD scope feature.

It is available free of charge to download from www.parker.com.

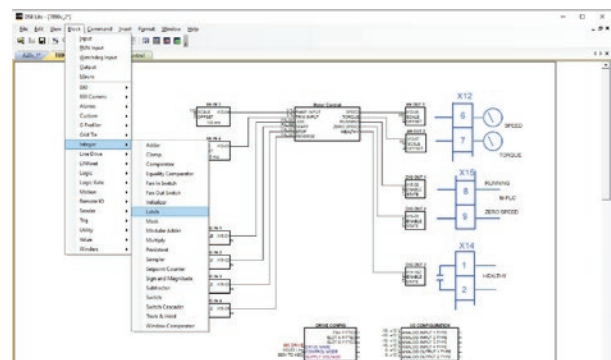
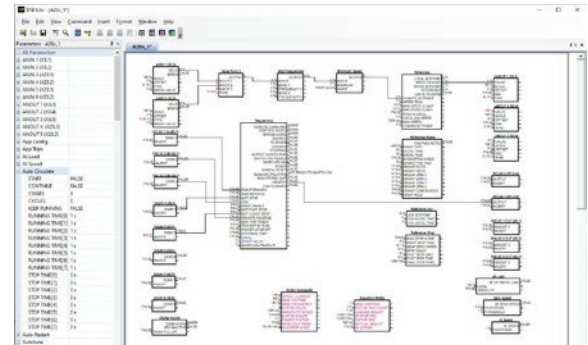

Accessories and Options

6901 Remote Mounting Keypad

The popular 6901 remote mounting keypad can be mounted away from the drive, such as on the door of an electrical enclosure. This interface allows users to configure, operate and monitor the drive without having to access the drive directly.

The remote keypad provides an alternative to the drive mounted keypad, offering a clear English language display and greater functionality. The remote mounting kit provides mounting bezel and a 1.5 m cable that is plugged into the RJ11 port on the drive.



Order Code	Description
6901-00-G	6901 DisplayKeypad
6052-00-G	6901 remote mounting kit

Cable Screening Bracket

Cable Screening Brackets are available for the AC15. These brackets offer a means of grounding the power cable screen connections, as well as supporting the power cables when connected to the drive.

Order Code	Description
ASP-0039-01	AC15 Bracket Kit - Frame 1
ASP-0039-02	AC15/20 Bracket Kit - Frame 2
ASP-0039-03	AC15/20 Bracket Kit - Frame 3, 400V
ASP-0039-04	AC15/20 Bracket Kit - Frame 4, 400V
ASP-0039-05	AC15/20 Bracket Kit - Frame 5, 400V
ASP-0039-06	AC15/20 Bracket Kit - Frame 3, 230V
ASP-0039-07	AC15/20 Bracket Kit - Frame 4, 230V
ASP-0039-08	AC15/20 Bracket Kit - Frame 5, 230V



ASP-0039-01



ASP-0039-02



ASP-0039-03



ASP-0039-04



ASP-0039-05



ASP-0039-06



ASP-0039-07



ASP-0039-08

Braking Resistor

During deceleration, or with an over-hauling load, the motor acts as a generator. Energy flows back from the motor into the DC link capacitors within the drive, causing their voltage to rise. If this voltage exceeds a maximum value, the drive will trip to protect the capacitors and internal power devices. The amount of energy that can be absorbed by the capacitors can vary between different applications causing the drive to trip on overvolts. To utilize the drive's onboard dynamic braking capability, high power resistor(s), connected across the DC link, allow the dissipation of this excess energy for fast stops or load braking.

Brake resistor selection

Brake resistor assemblies must be rated to absorb both peak braking power during deceleration and the average power over the complete cycle.

$$\text{Peak braking power} = \frac{0.0055J \times (n_1^2 - n_2^2) \text{ (W)}}{t_b}$$

$$\text{Average braking power } P_{av} = \frac{P_{pk} \times t_b}{t_c}$$

J: total inertia [kgm²]

n₁: initial speed [min⁻¹]

n₂: final speed [min⁻¹]

t_b: braking time [s]

t_c: cycle time [s]



Model	Impedance [Ω]	Nom. Power [W]	Dimensions [mm]							
			L1	L2	L3	W	H	D	a	b
CZ467715	500	60	100	87	60	22	41	4.3	10	12
CZ467714	200	100	165	152	125	22	41	4.3	10	12
CZ389853	100	100	165	152	125	22	41	4.3	10	12
CZ467717	100	200	165	146	125	30	60	4.3	13	17
CZ463068	56	200	165	146	125	30	60	4.3	13	17
CZ388396	36	500	335	316	295	30	60	4.3	13	17
CZ467716	56	500	335	316	295	30	60	4.3	13	17

Overload 5 s: 500 %

Overload 3 s: 833 %

Overload 1 s: 2500 %

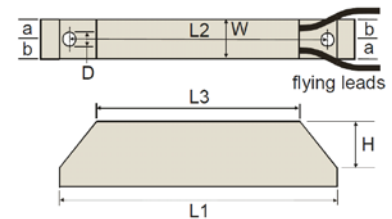

EMC Filter

AC15 are supplied as standard with an EMC filter fitted that meets the requirements of a class C3 environment. For class C2 or C1 environments, an additional external filter may be required. An internal wire link may be easily removed to disconnect the Y capacitors for those installations where earth currents are undesirable.

Order Code

AC15

	1		2	3		4		5	6
Order example	15G	-	1	1	-	0025	-	B	F

1	Device Family
15G	AC15 Series, General Purpose AC Drive
2	Voltage
1	230 V Single Phase
3	230 V Three Phase
4	400 V Three Phase
3&4	Frame Size & Current Rating (Heavy Duty)
230Vac, Single Phase Supply Voltage	
1-0025	Frame 1 - 2.5A (0.37kW)
1-0045	Frame 1 - 4.5A (0.75kW)
1-0070	Frame 1 - 7A (1.5kW)
2-0100	Frame 2 - 10A (2.2kW)
230Vac, Three Phase Supply Voltage	
1-0025	Frame 1 - 2.5A (0.37kW)
1-0045	Frame 1 - 4.5A (0.75kW)
1-0070	Frame 1 - 7A (1.5kW)
2-0100	Frame 2 - 10A (2.2kW)
3-0170	Frame 3 - 17A (4.0kW)
4-0210	Frame 4 - 21A (5.5kW)
5-0300	Frame 5 - 30A (7.5kW)
5-0400	Frame 5 - 40A (11kW)
400Vac, Three Phase Supply Voltage	
1-0012	Frame 1 - 1.2A (0.37kW)
1-0020	Frame 1 - 2A (0.75kW)
1-0040	Frame 1 - 4A (1.5kW)
2-0065	Frame 2 - 6.5A (2.2kW)
2-0090	Frame 2 - 9A (4.0kW)
3-0120	Frame 3 - 12A (5.5kW)
3-0170	Frame 3 - 17A (7.5kW)
4-0230	Frame 4 - 23A (11kW)
4-0320	Frame 4 - 32A (15kW)
5-0380	Frame 5 - 38A (18.5kW)
5-0440	Frame 5 - 44A (22kW)
5-0600	Frame 5 - 60A (30kW)
5	Brake Switch
B	Brake Switch Fitted
6	EMC Filter
F	Category C3 Filtered



Parker's Motion & Control Technologies

At Parker, we're guided by a relentless drive to help our customers become more productive and achieve higher levels of profitability by engineering the best systems for their requirements. It means looking at customer applications from many angles to find new ways to create value. Whatever the motion and control technology need, Parker has the experience, breadth of product and global reach to consistently deliver. No company knows more about motion and control technology than Parker. For further info call 00800 27 27 5374



Aerospace

Key Markets

Aftermarket services
Commercial transports
Engines
General & business aviation
Helicopters
Launch vehicles
Military aircraft
Missiles
Power generation
Regional transports
Unmanned aerial vehicles

Key Products

Control systems & actuation products
Engine systems & components
Fluid conveyance systems & components
Fluid metering, delivery & atomization devices
Fuel systems & components
Fuel tank inerting systems
Hydraulic systems & components
Thermal management
Wheels & brakes



Climate Control

Key Markets

Agriculture
Air conditioning
Construction Machinery
Food & beverage
Industrial machinery
Life sciences
Oil & gas
Precision cooling
Process
Refrigeration
Transportation

Key Products

Accumulators
Advanced actuators
CO₂ controls
Electronic controllers
Filter driers
Hand shut-off valves
Heat exchangers
Hose & fittings
Pressure regulating valves
Refrigerant distributors
Safety relief valves
Smart pumps
Solenoid valves
Thermostatic expansion valves



Electromechanical

Key Markets

Aerospace
Factory automation
Life science & medical
Machine tools
Packaging machinery
Paper machinery
Plastics machinery & converting
Primary metals
Semiconductor & electronics
Textile
Wire & cable

Key Products

AC/DC drives & systems
Electric actuators, gantry robots & slides
Electrohydraulic actuation systems
Electromechanical actuation systems
Human machine interface
Linear motors
Stepper motors, servo motors, drives & controls
Structural extrusions



Filtration

Key Markets

Aerospace
Food & beverage
Industrial plant & equipment
Life sciences
Marine
Mobile equipment
Oil & gas
Power generation & renewable energy
Process
Transportation
Water Purification

Key Products

Analytical gas generators
Compressed air filters & dryers
Engine air, coolant, fuel & oil filtration systems
Fluid condition monitoring systems
Hydraulic & lubrication filters
Hydrogen, nitrogen & zero air generators
Instrumentation filters
Membrane & fiber filters
Microfiltration
Sterile air filtration
Water desalination & purification filters & systems



Fluid & Gas Handling

Key Markets

Aerial lift
Agriculture
Bulk chemical handling
Construction machinery
Food & beverage
Fuel & gas delivery
Industrial machinery
Life sciences
Marine
Mining
Mobile
Oil & gas
Renewable energy
Transportation

Key Products

Check valves
Connectors for low pressure fluid conveyance
Deep sea umbilicals
Diagnostic equipment
Hose couplings
Industrial hose
Mooring systems & power cables
PTFE hose & tubing
Quick couplings
Rubber & thermoplastic hose
Tube fittings & adapters
Tubing & plastic fittings



Hydraulics

Key Markets

Aerial lift
Agriculture
Alternative energy
Construction machinery
Forestry
Industrial machinery
Machine tools
Marine
Material handling
Mining
Oil & gas
Power generation
Refuse vehicles
Renewable energy
Truck hydraulics
Turf equipment

Key Products

Accumulators
Cartridge valves
Electrohydraulic actuators
Human machine interfaces
Hybrid drives
Hydraulic cylinders
Hydraulic motors & pumps
Hydraulic systems
Hydraulic valves & controls
Hydrostatic steering
Integrated hydraulic circuits
Power take-offs
Power units
Rotary actuators
Sensors



Pneumatics

Key Markets

Aerospace
Conveyor & material handling
Factory automation
Life science & medical
Machine tools
Packaging machinery
Transportation & automotive

Key Products

Air preparation
Brass fittings & valves
Manifolds
Pneumatic accessories
Pneumatic actuators & grippers
Pneumatic valves & controls
Quick disconnects
Rotary actuators
Rubber & thermoplastic hose & couplings
Structural extrusions
Thermoplastic tubing & fittings
Vacuum generators, cups & sensors



Process Control

Key Markets

Alternative fuels
Biopharmaceuticals
Chemical & refining
Food & beverage
Marine & shipbuilding
Medical & dental
Microelectronics
Nuclear Power
Offshore oil exploration
Oil & gas
Pharmaceuticals
Power generation
Pulp & paper
Steel
Water/wastewater

Key Products

Analytical Instruments
Analytical sample conditioning products & systems
Chemical injection fittings & valves
Fluoropolymer chemical delivery fittings, valves & pumps
High purity gas delivery fittings, valves, regulators & digital flow controllers
Industrial mass flow meters/controllers
Permanent no-weld tube fittings
Precision industrial regulators & flow controllers
Process control double block & bleeds
Process control fittings, valves, regulators & manifold valves



Sealing & Shielding

Key Markets

Aerospace
Chemical processing
Consumer
Fluid power
General industrial
Information technology
Life sciences
Microelectronics
Military
Oil & gas
Power generation
Renewable energy
Telecommunications
Transportation

Key Products

Dynamic seals
Elastomeric o-rings
Electro-medical instrument design & assembly
EMI shielding
Extruded & precision-cut, fabricated elastomeric seals
High temperature metal seals
Homogeneous & inserted elastomeric shapes
Medical device fabrication & assembly
Metal & plastic retained composite seals
Shielded optical windows
Silicone tubing & extrusions
Thermal management
Vibration dampening

www.parker.com



European Headquarters
La Tuilière 6, 1163 Etoy,
Switzerland
Tel: +41 21 821 85 00

Your authorized distributor