

OSP-E..B Belt Actuator with Internal Plain Bearing Guide



Contents

Description	Page
Overview	40
Technical Data	43
Dimensions	48
Order Instructions	50

BELT ACTUATOR WITH INTERNAL PLAIN BEARING GUIDE FOR POINT-TO-POINT APPLICATIONS

A completely new generation of actuators which can be integrated into any machine layout neatly and simply.

Advantages

- Precise path and position control
- High speed operation
- Easy installation
- Low maintenance
- Ideal for precise point-to-point applications

Features

- Integrated drive and guidance system
- Tandem configuration with increased carrier distance for higher moment supports
- Long available strokes
- Complete motor and control packages
- Diverse range of accessories and mountings
- Bi-parting and special options available



Take the easy route and load all the dimensions into your system. The file is suitable for all current CAD systems – available on CD-Rom or at www.parker-origa.com

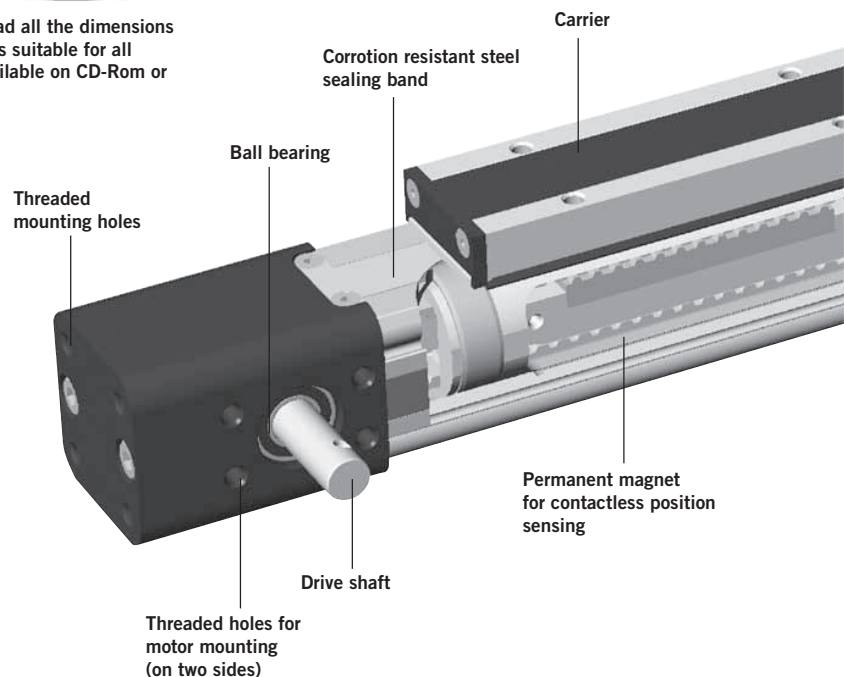
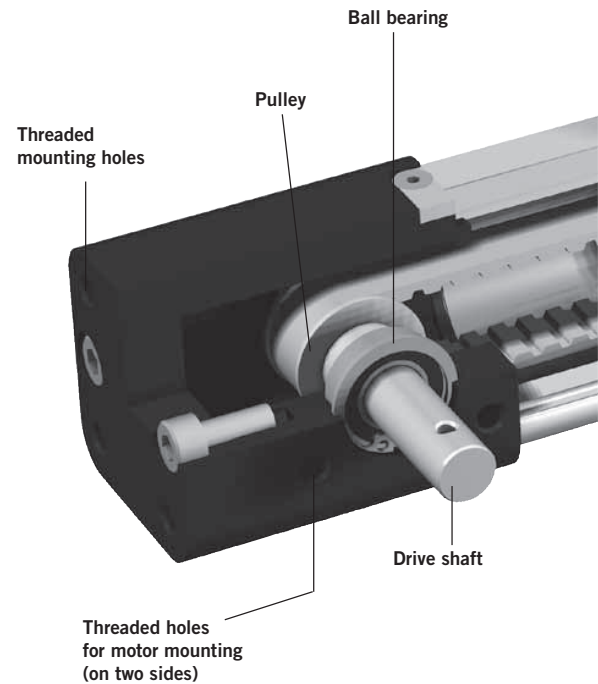

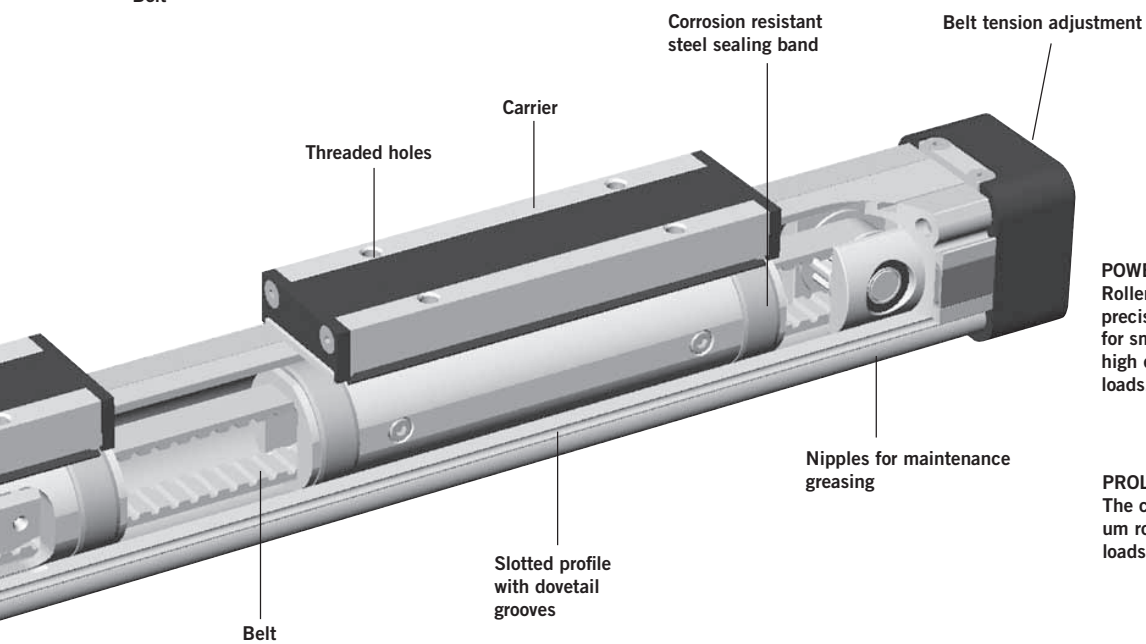
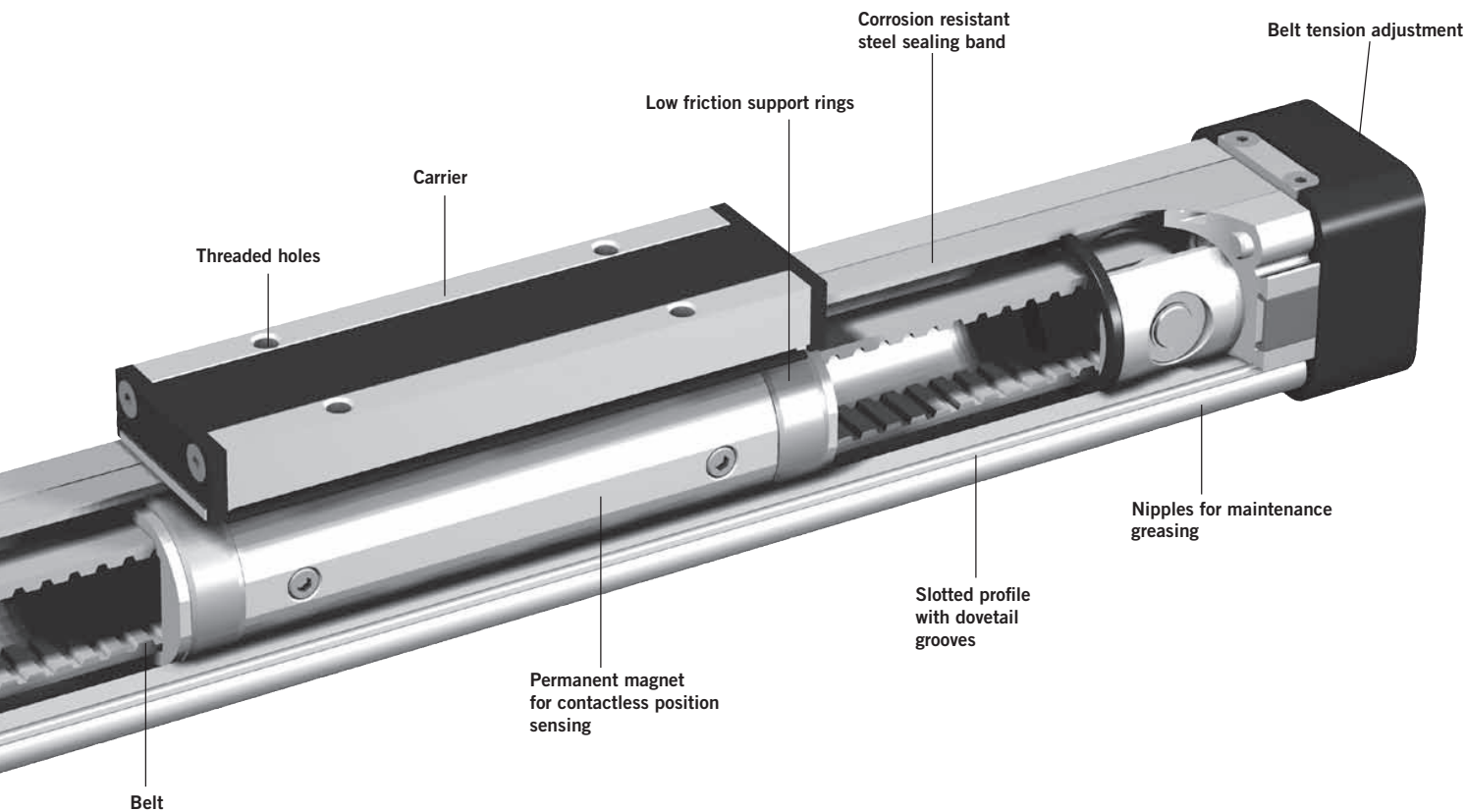

POWERSLIDE
Roller bearing precision guidance for smooth travel and high dynamic or static loads.

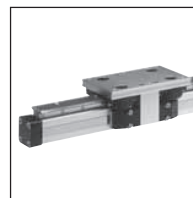

PROLINE
The compact aluminum roller guide for high loads and velocities.

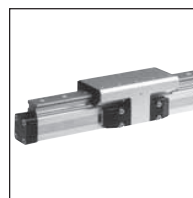

Tandem configuration with increased carrier distance for higher moment supports.
Bi-parting version for precise synchronized movements

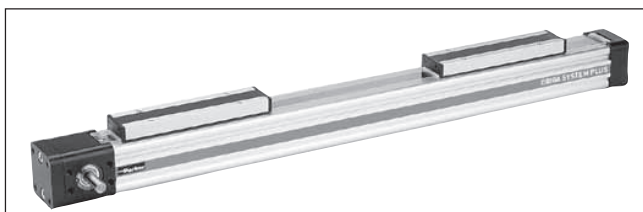

The dovetailed mounting rails of the new actuator expand its function into that of a universal system carrier. Modular system components are simply clamped on.

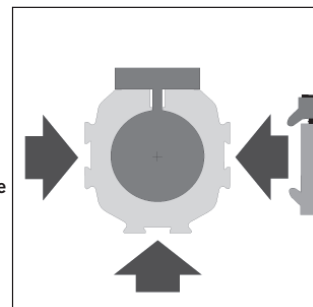

OPTIONS AND ACCESSORIES

OSP-E..B BELT ACTUATOR WITH INTERNAL PLAIN BEARING GUIDE

STANDARD VERSIONS OSP-E..B

Carrier with internal guidance and magnet packet for contactless position sensing. Dovetail profile for mounting of accessories and the actuator itself.

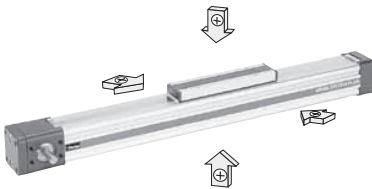

DRIVE SHAFT VERSIONS
– Plain shaft or
– double plain shaft (Option)
e.g. to drive two actuators
in parallel.



OPTIONS

TANDEM
For higher moment support.



BI-PARTING
For perfectly synchronised
bi-parting movements.



ACCESSORIES

MOTOR MOUNTING



END CAP MOUNTING

For end-mounting of the actuator.



PROFILE MOUNTING

For supporting long actuators or
mounting the actuator on the dovetail
grooves.

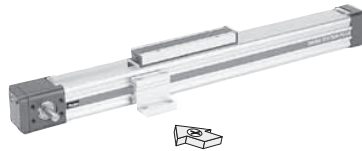

CLEVIS MOUNTING

Carrier with tolerance and parallelism
compensation to drive external linear
guides.

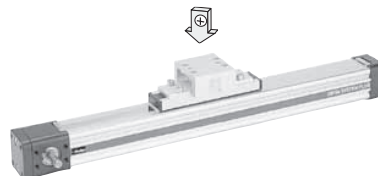

INVERSION MOUNTING

The inversion mounting, mounted on
the carrier, transfers the driving force
to the opposite side, e.g. for dirty
environments.

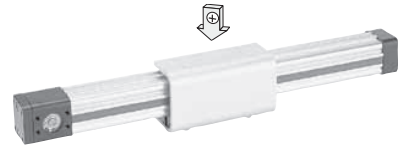

MAGNETIC SWITCHES SERIES RST AND EST

For contactless position sensing of
end stop and intermediate carrier
positions.



Characteristics			
Characteristics	Symbol	Unit	Description
General Features			
Series			OSP-E..B
Name			Belt Actuator with internal Plain Bearing Guide
Mounting			See drawings
Temperature range	ϑ_{\min} ϑ_{\max}	$^{\circ}\text{C}$ $^{\circ}\text{C}$	-30 +80
Weight (mass)		kg	See table
Installation			See table
Material	Slotted profile		Extruded anodized aluminium
	Belt		Steel-corded polyurethane
	Pulley		Aluminium
	Guide bearings		Low friction plastic
	Sealing band		Hardened corrosion resistant steel
	Screws, nuts		Zinc plated steel
Mountings		Zinc plated steel and aluminium	
Encapsulation class	IP	54	

Weight (mass) and Inertia					
Series	at stroke 0 m	Weight (mass) [kg]		Inertia [$\times 10^{-6}$ kgm ²]	
		ad per meter stroke	moving mass	at stroke 0 m	ad per meter stroke
OSP-E25B	0.9	1.6	0.2	25	6.6
OSP-E32B	1.9	3.2	0.4	43	10
OSP-E50B	5.2	6.2	1.0	312	45
OSP-E25B*	1.2	1.6	0.5	48	6.6
OSP-E32B*	2.3	3.2	0.8	83	10
OSP-E50B*	6.3	6.2	2.1	585	45

* Version: Tandem and Bi-parting (Option)

Installation Instructions

Use the threaded holes in the end cap for mounting the actuator. See if Profile Mountings are needed using the maximum allowable unsupported length graph on page 45. At least one end cap must be secured to prevent axial sliding when profile mounting is used.

When the actuator is moving an externally guided load, the compensation must be used.

The actuators can be fitted with the standard carrier mounting facing in any direction.

To prevent contamination such as fluid ingress, the actuator should be fitted with its sealing band facing downwards. The inversion mounting can be fitted to transfer the driving force to the opposite side.

Maintenance

All moving parts are long-term lubricated for a normal operational environment. Parker Origa recommends a check and lubrication of the actuator, and if necessary a change of the belt and wear parts, after an operation time of 12 months of operation or 3 000 km travel of distance. Additional greasing is easily done by using nipples in the slotted profile. Please refer to the operating instructions supplied with the actuator.

First service start-up

The maximum values specified in the technical data sheet for the different products must not be exceeded. Before taking the actuator as a machine into service, the user must ensure the adherence to the EC Machine Directive 2006/42/EG.

OSP-E..B Belt Actuator with internal Plain Bearing Guide

Size 25, 32, 50



Standard Versions:

- Standard carrier with internal plain bearing guide
- Dovetail profile for mounting of accessories and the actuator itself
- Position of Drive Shafts



Options:

- Tandem-Version
- Bi-parting version for synchronized movements
- Drive shaft with double plain shaft

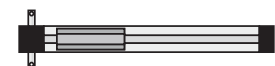

Sizing Performance Overview

Maximum Loadings

Sizing of Actuator

The following steps are recommended for selection:

1. Required acceleration,
2. Required torque is shown on page 46 and 47.
3. Check that maximum values in the table 3 are not exceeded
4. Drive shaft by using table T2. (Pay attention to note under table) If value is lower than required, overview the moving profile or select if possible a bigger unit.
5. Before sizing and specifying the motor, the average torque must be calculated using the cycle time of the application.
6. Check that the maximum allowable unsupported length is not exceeded (see on page 45).

Performance Overview				
Characteristics	Unit	Description		
Size		OSP-E25B	OSP-E32B	OSP-E50B
Max. speed	[m/s]	2	3	5
Linear motion per revolution, drive shaft	[mm]	60	60	100
Max. rpm drive shaft	[min ⁻¹]	2 000	3 000	3 000
Max. effective action force	< 1 m/s: [N]	50	150	425
	1- 2 m/s: [N]	50	120	375
F _A at speed	> 2 m/s: [N]	–	100	300
No-load torque	[Nm]	0.4	0.5	0.6
Max. acceleration/deceleration	[m/s ²]	10	10	10
Repeatability	[mm/m]	±0.05	±0.05	±0.05
Max. stroke length OSP-E..B	[mm]	3000	5000	5000
Max. stroke length OSP-E..B*	[mm]	2 x 1500	2 x 2500	2 x 2500

* Bi-parting version

Maximum Permissible Torque on Drive Shaft Speed / Stroke

T2

OSP-E25B				OSP-E32B				OSP-E50B			
Speed [m/s]	Torque [Nm]	Stroke [m]	Torque [Nm]	Speed [m/s]	Torque [Nm]	Stroke [m]	Torque [Nm]	Speed [m/s]	Torque [Nm]	Stroke [m]	Torque [Nm]
1	0.9	1	0.9	1	2.3	1	2.3	1	10.0	1	10.0
2	0.9	2	0.9	2	2.0	2	2.3	2	9.5	2	10.0
		3	0.9	3	1.8	3	2.3	3	9.0	3	9.0
						4	2.3	4	8.0	4	7.0
						5	1.8	5	7.5	5	6.0

Important:

The maximum permissible torque on the drive shaft is the lowest value of the speed- or stroke-dependent torque value.

Example above:

OSP-E32B stroke 2 m, required speed 3 m/s;
From table T2: speed 3 m/s gives 1.8 Nm and stroke 2 m gives 2.3 Nm.
Max. torque for this application is 1.8 Nm.

Forces, loads and moments

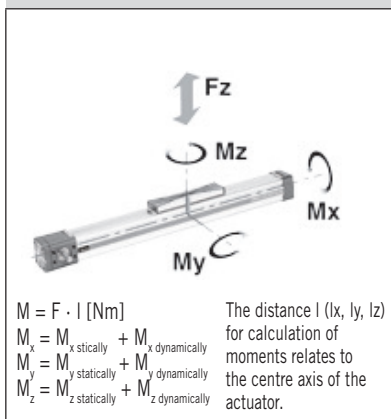

Combined Loads

If the actuator is subjected to several forces, loads and moments at the same time, the maximum load is calculated with the equation shown here.

The maximum permissible loads must not be exceeded.

Maximum Permissible Loads

T3

Series	Max. applied load Fz [N]	Max. moments [Nm]		
		Mx	My	Mz
OSP-E25B	160	2	12	8
OSP-E32B	300	8	25	16
OSP-E50B	850	16	80	32
OSP-E..B Bi-partional	The maximum load F must be equally distributed among the two carriers.			

Equation for Combined Loads

$$\frac{F_z}{F_z \text{ (max)}} + \frac{M_x}{M_x \text{ (max)}} + \frac{M_y}{M_y \text{ (max)}} + \frac{M_z}{M_z \text{ (max)}} \leq 1$$

The total of the loads must not exceed >1 under any circumstances.

Maximum permissible unsupported length – Placing of Profile Mounting

Series OSP-E..B

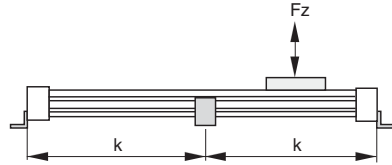
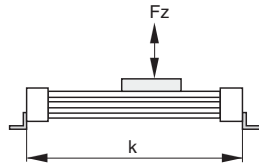

Series OSP-E..B
Bi-parting version

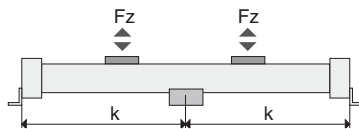
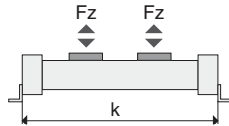

k = Maximum permissible distance between mountings/mid-section support for a given load F.

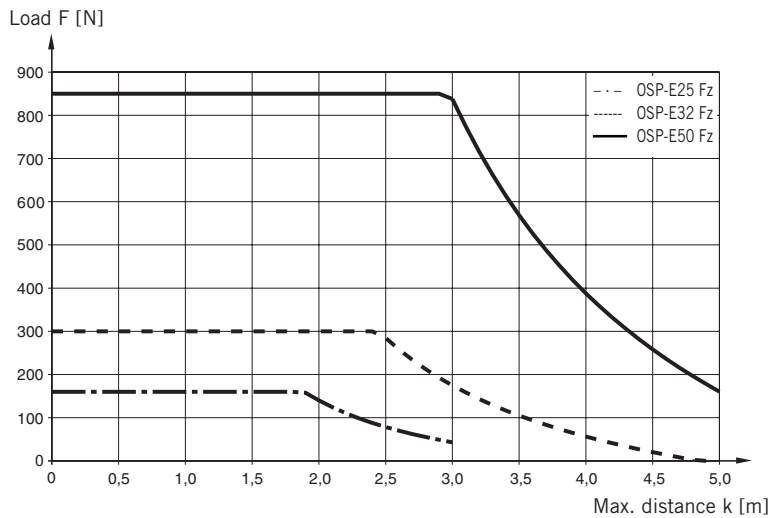

(Up to the curve in the above graph the deflection will be max. 0.2 % of distance k)

Maximum Permissible Unsupported Length

Stroke Length

The stroke lengths of the actuators are available in multiples of 1 mm up to max.

OSP-E25B: 3 m / 2 x 1.5 m *

OSP-E32B: 5 m / 2 x 2.5 m *

OSP-E50B: 5 m / 2 x 2.5 m *

* Version: Bi-partional

Other stroke lengths are available on request.

The end of stroke must not be used as a mechanical stop.

Allow an additional safety clearance at both ends equivalent to the linear movement of one revolution of the drive shaft.

The use of an AC motor with frequency converter normally requires a larger safety clearance than that required for servo systems.

For advise, please contact your local Parker Origa technical support department.

Mounting on the Drive Shaft

Do not expose the drive shaft to uncontrolled axial or radial forces when mounting coupler or pulley, a steadying block should be used.

Pulley

Minimum allowable number of teeth Z (AT5) at maximum applied torque.

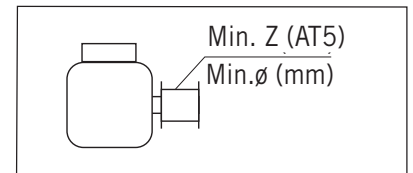

Series	Min. Z	Min. ø
OSP-E25B	24	38
OSP-E32B	24	38
OSP-E50B	36	57

Required Acceleration

Distance / Time Graph

Using the required travel distance and total time, the adjacent graphs show the required acceleration based on maximum speed.

The graphs assume that acceleration and deceleration are equal.

Please note that specifying non-essential high acceleration or short cycle time will result in an oversized motor.

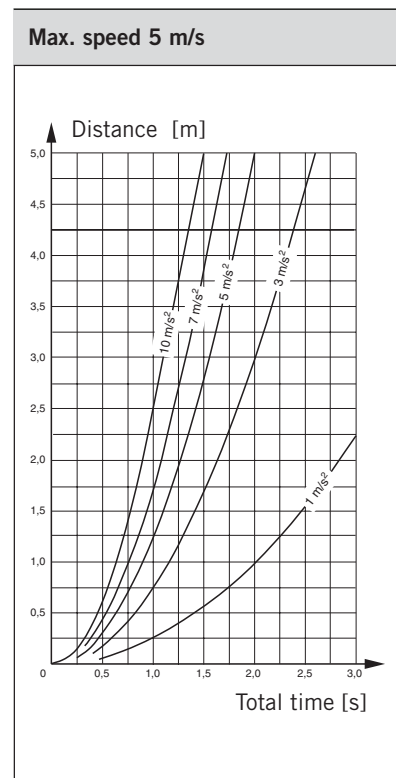
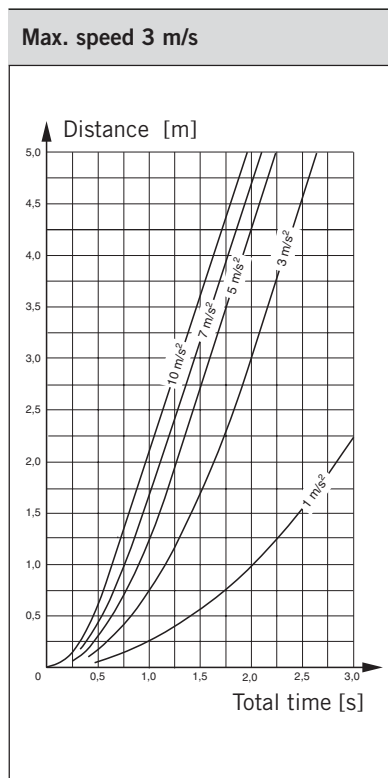
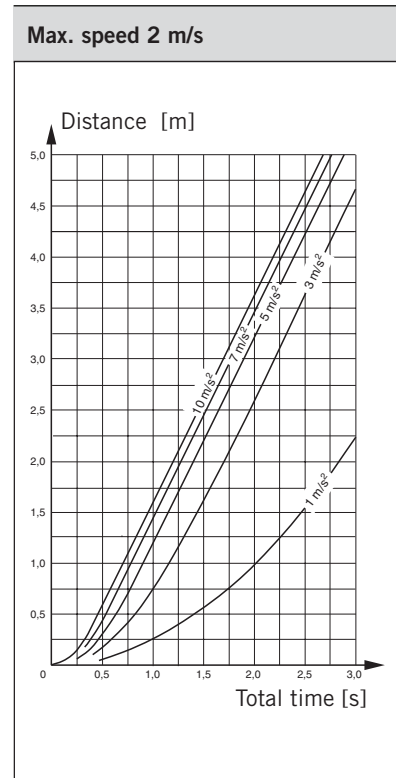
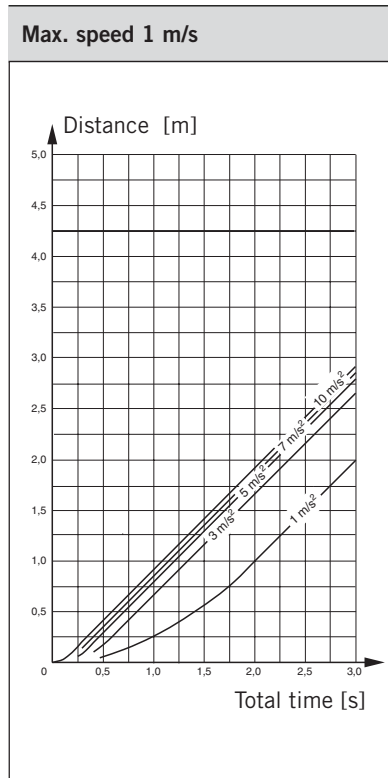

Required Torque / Mass

Size OSP-E25B,
Horizontal Application

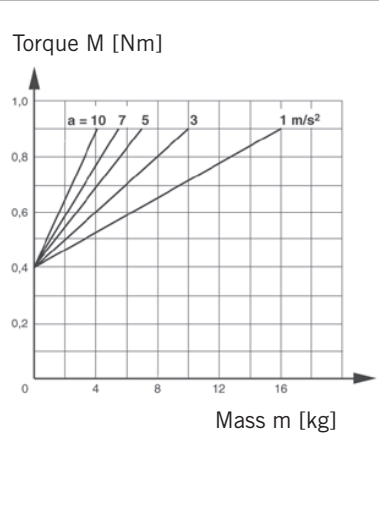

Size OSP-E25B,
Vertical Application

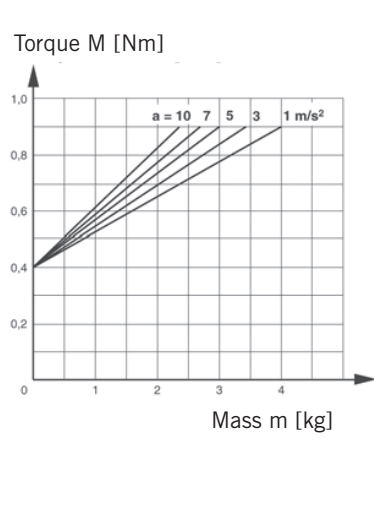

Using the known mass, the direction of the application and the required acceleration from the distance-time graphs, the actuator can be sized and the required torque is shown in the adjacent graphs. Mass in graphs = Load + moving mass of the actuator (according to the weight chart on data sheet 43 ff).

Size OSP-E32B,
Horizontal Application

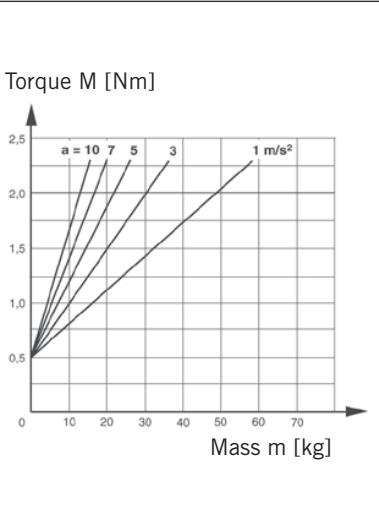

Size OSP-E32B,
Vertical Application

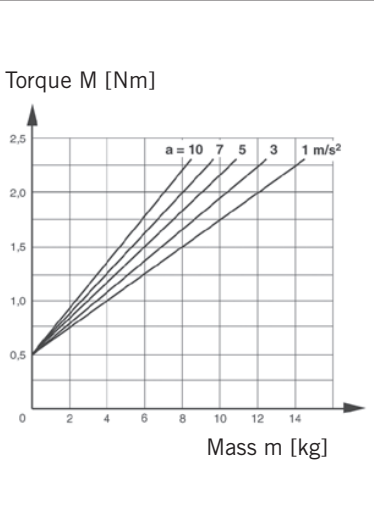

Please note:

When using an additional guide, please add the mass of the carriage to the total moving mass.

Size OSP-E50B,
Horizontal Application

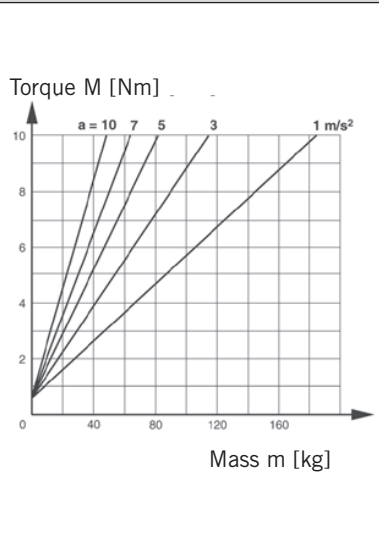

Size OSP-E50B,
Vertical Application

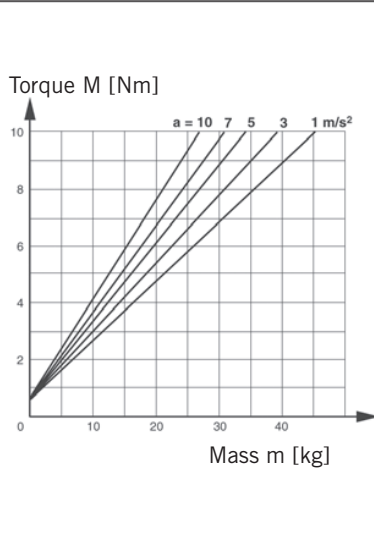

OSP-E..B
Belt Actuator with Internal Plain Bearing Guide- Basic Unit

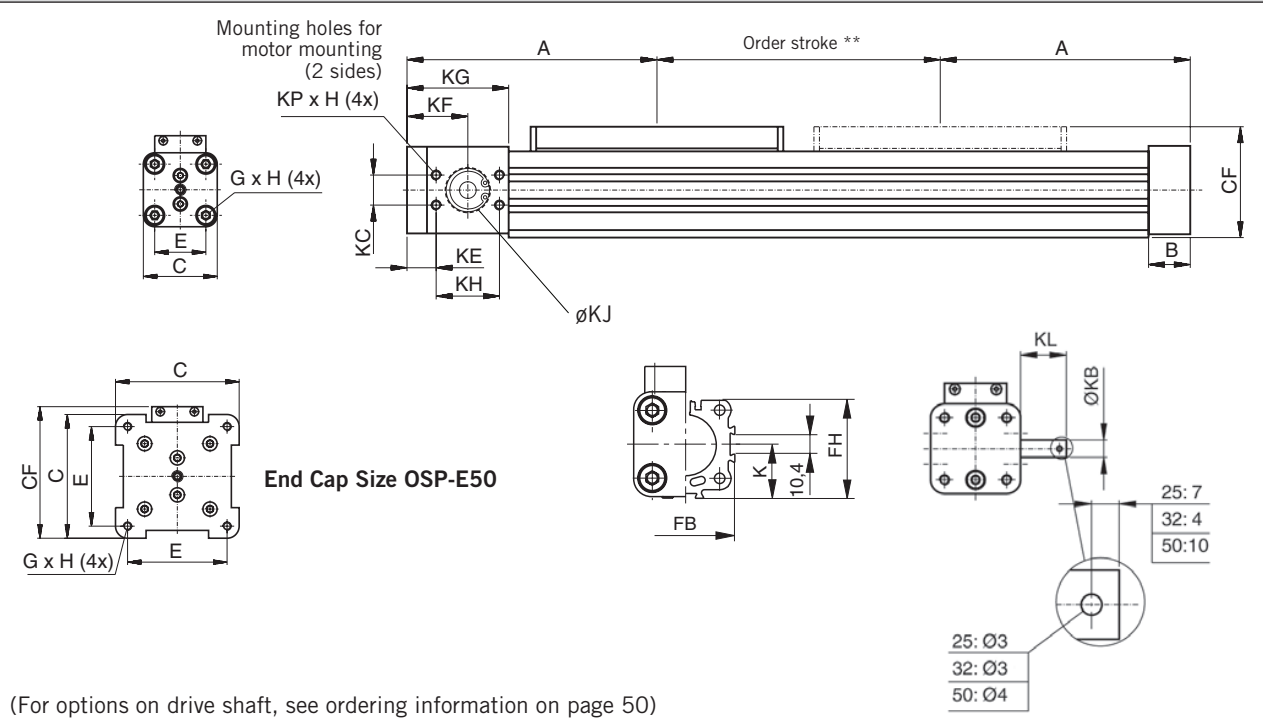

*** Note:**

The mechanical end position must not be used as a mechanical end stop. Allow an additional safety clearance at both ends equivalent to the linear movement of one revolution of the drive shaft, but at least 100 mm.

Order stroke = required travel + 2 x safety distance.

The use of an AC motor with frequency converter normally requires a larger safety clearance than that required for servo systems. For further information please contact your local Parker Origa representative.

Option – Tandem

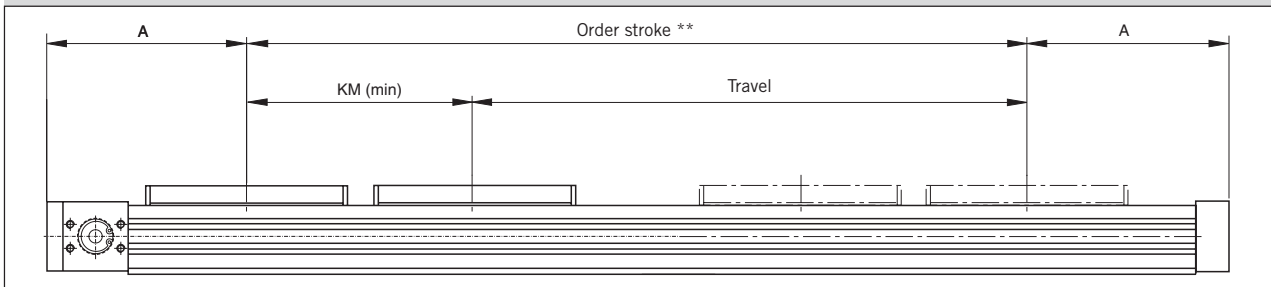

** Order stroke = required travel + KM min + 2 x safety distance

Option – Bi-parting

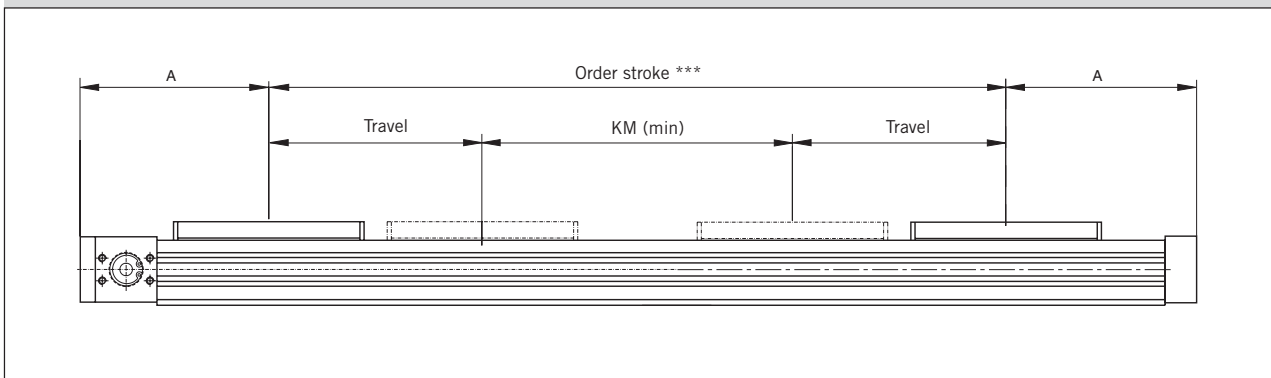

*** Order stroke = 2 x required travel + KM min + 2 x safety distance

Standard Carrier

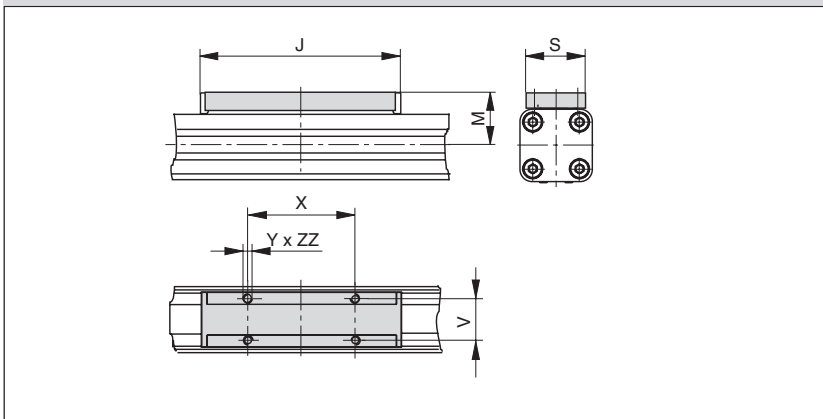

Dimension Table [mm]

Series	A	B	C	E	G x H	J	K	M	S	V	X	Y	CF
OSP-E25B	125	22	41	27	M5 x 10	117	21.5	31	33	25	65	M5	52.5
OSP-E32B	150	25	52	36	M6 x 12	152	28.5	38	36	27	90	M6	66.5
OSP-E50B	200	25	87	70	M6 x 12	200	43.0	49	36	27	110	M6	92.5



Series	FB	FH	KB	KC	KE	KF	KG	KH	KJ	KL	KM _{min}	KM _{recc.}	KP x H	ZZ
OSP-E25B	40	39.5	10 _{j6}	15	22.0	37.0	57	30	19 ^{H7}	24	130	190	M5 x 10	8
OSP-E32B	52	51.7	10 _{j6}	18	17.5	36.5	61	38	26 ^{H7}	26	170	230	M6 x 12	10
OSP-E50B	76	77.0	16 _{h8}	32	23.5	48.5	85	50	40 ^{H7}	34	220	320	M8 x 16	10

Order Instructions OSPE25 — 0 0 0 0 0 — 00000 — 0 0 0 0 0 0

Size of actuator	
25	Size 25
32	Size 32
50	Size 50

Type of actuator	
0	Belt actuator with internal plain bearing guide

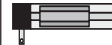
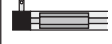
Carriage	
0	Standard
1*	Tandem
2*	Bi-parting

Drive shaft / motor mounting position	
0	Plain shaft / motor standard 
1	Plain shaft / motor 180° standard 
2*	Double plain shaft 

* Option





Gear mounting*				
Size		25	32	50
0	without	x	x	x
1	LP050 i = 5	x	x	
2	LP050 i = 10	x	x	
3	LP070 i = 3		x	x
4	LP070 i = 5		x	x
5	LP070 i = 10		x	x

Info: For gears the mounting kit of the motor must be specified.
 LP050: A0, A1, A2
 LP070: A1, A2, A3

Order stroke
5 digits input in mm

Mounting Kit for Motor and Gear				
Size		25	32	50
0 -	without	x	x	x
A 0	SY563T	x	x	
A 1	SY873T	x	x	x
A 2	SMx60 xx xxx 8 11 ...	x	x	
A 3	SMx82 xx xx 8 14 ...		x	x
A 4	SMx100 xx xx 5 19...			x
A 7	PS60		x	x
C 0	LP050 / PV40-TA	x	x	
C 1	LP070 / PV60-TA		x	x

Info: Motor and Gear mounting dimensions see page 193

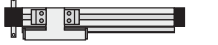
Guide position		
0	Standard	
1	180° Standard	
0	Standard	
1	180° Standard	
0	Standard	
1	180° Standard	

External guide / carriage mounting*	
0	Without
6	PL Proline
E	PS Power slide 25/25
F	PS Power slide 25/35, 32/35
G	PS Power slide 25/44, 32/44
H	PS Power slide 50/60
I	PS Power slide 50/76
M	Inversion
R	Compensation
S	Compensation low back lash
see page 99 ff	

Niro	
0	Standard
1*	Niro

* Option

Accessories - please order separately	
Description	Page
Motor mounting	136 ff
Multi-axis system for actuators	177 ff

Magnetic switches *	
0	Without
1	1 pc. RST-K 2NO / 5m cable
2	1 pc. RST-K 2NC / 5m cable
3	2 pc. RST-K 2NC / 5m cable
4	2 pc. RST-K 2NC, 1 pc. RST-K 2NO / 5m cable
5	1 pc. RST-S 2NO / M8 plug
6	1 pc. RST-S 2NC / M8 plug
7	2 pc. RST-S 2NC / M8 plug
8	2 pc. RST-S 2NC, 1 pc. RST-S 2NO / M8 plug
A	1 pc. EST-S NPN / M8 plug
B	2 pc. EST-S NPN / M8 plug
C	3 pc. EST-S NPN / M8 plug
D	1 pc. EST-S PNP / M8 plug
E	2 pc. EST-S PNP / M8 plug
F	3 pc. EST-S PNP / M8 plug
see page 165 ff	

Profile mounting *	
0	Without
1	1 pair type E1
2	1 pair type D1
3	1 pair type MAE
4	2 pair type E1
5	2 pair type D1
6	2 pair type MAE
7	3 pair type E1
8	3 pair type D1
9	3 pair type MAE
K	1 pair type E2
L	1 pair type E3
M	1 pair type E4
N	2 pair type E2
P	2 pair type E3
Q	2 pair type E4
R	3 pair type E2
S	3 pair type E3
T	3 pair type E4
see pages 147 ff and 161 ff	

End cap mounting *	
0	Without
1	1 pair type A1 (size 25 and 32) or C1 (size 50)
2	1 pair type A2 (size 25 and 32) or C2 (size 50)
3	1 pair type A3 (size 25 and 32) or C3 (size 50)
4	1 pair type B1 (size 25 and 32) or C4 (size 50)
5	1 pair type B4 (size 25 and 32)
see pages 147 and 161 ff	