

HDP+ – Cleanliness guaranteed



HDP+

Product highlights

Positioning accuracy: Minimal backlash and extreme torsional rigidity ensure maximum positioning accuracy

New freedom in design through direct process integration

Resistance: Resistant against chemical cleaning agents and disinfectants

Cleaning: Fast, efficient and safe cleaning, also suitable for CIP processes

Consistently high performance: Constant backlash throughout the service life of the gearbox ensures a consistently high performance

Max. achievable leak tightness: IP69X (max. 30 bar)

Sterile, highly dynamic and outstanding positioning accuracy – the HDP+ meets the strict hygiene requirements of production and packaging facilities. The gearbox in hygienic design not only offers you maximum safety against contamination-related product and process risks, but also guarantees maximum system availability and productivity.

HDP+ is setting new industrial standards in hygienic design

Benefits for system manufacturers

- Integration in a system constructed according to Hygiene Design requirements (certification available)
- Meets legal obligations (machinery directive, food hygiene regulation)
- Reduction of individual parts simplifies production / assembly and allows a more compact machine design
- Greater overall system effectiveness
- Competitive advantage through innovation

Benefits for operators

- Easier, faster cleaning: shorter CIP / SIP times
- Improved reliability and longer life
- Quick and easy disassembly
- Reduced consumption of cleaning materials
- Minimal costs for maintenance and repair
- Cost savings: competitive advantage and lower end user price
- Increased food safety



Used for fish processing



Used for filling and packing milk products



More information on hygienic design solutions: Simply scan the QR code with your smartphone.

Smooth rolled surface in hygienic steel 1.4404

Triple sealing concept guarantees optimal reliability

Designed in line with EHEDG guidelines, FDA certified

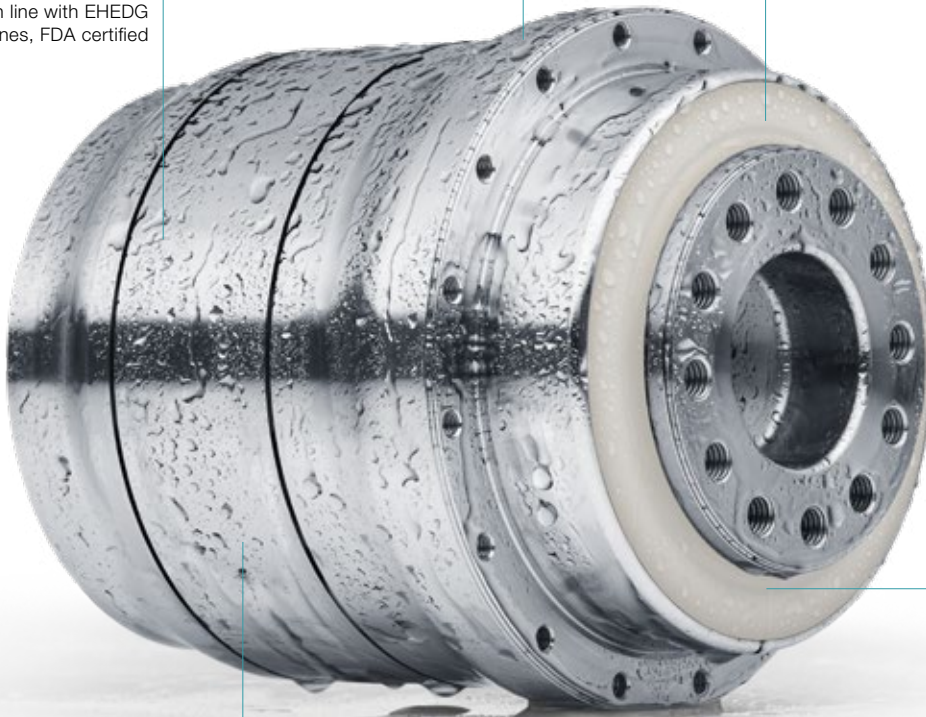

Seals resistant to cleaning materials have IP69X protection (max. 30 bar)

No dead spaces

Application-spec. solutions



Used for portioning meat products



The high-precision HDP* is ideal for Delta robotics applications

HDP+ 010 MA 2-stage

			2-stage					
Ratio	<i>i</i>		22	27.5	38.5	55		
Max. torque ^{a) b)}	T_{2a}	Nm	252	252	252	252		
		in.lb	2230	2230	2230	2230		
Max. acceleration torque ^{b)} (max. 1000 cycles per hour)	T_{2B}	Nm	185	185	185	185		
		in.lb	1637	1637	1637	1637		
Nominal torque (at n_n)	T_{2N}	Nm	140	137	139	147		
		in.lb	1242	1213	1230	1303		
Emergency stop torque ^{a) b)} (permitted 1000 times during the service life of the gearbox)	T_{2Not}	Nm	525	525	525	525		
		in.lb	4647	4647	4647	4647		
Permitted average input speed (at T_{2a} and 20 °C ambient temperature) ^{d)}	n_{1N}	rpm	4000	4000	4000	4000		
Max. input speed	n_{1Max}	rpm	7500	7500	7500	7500		
Mean no load running torque ^{b)} (at $n_1 = 3000$ rpm and 20 °C gearbox temperature)	T_{012}	Nm	0.52	0.47	0.38	0.38		
		in.lb	4.6	4.2	3.4	3.4		
Max. backlash	j_t	arcmin	≤ 1					
Torsional rigidity ^{b)}	C_{t21}	Nm/arcmin	43	43	43	42		
		in.lb/arcmin	381	381	381	372		
Tilting rigidity	C_{2K}	Nm/arcmin	225					
		in.lb/arcmin	1991					
Max. axial force ^{c)}	F_{2AMax}	N	2795					
		lb _f	629					
Max. tilting moment	M_{2KMax}	Nm	400					
		in.lb	3540					
Efficiency at full load	η	%	94					
Service life	L_h	h	> 20000					
Weight (incl. standard adapter plate)	m	kg	7.3					
		lb _m	16.1					
Operating noise (at reference ratio and reference speed – ratio-specific values available in cymex [®])	L_{PA}	dB(A)	≤ 56					
Max. permitted housing temperature		°C	+90					
		F	194					
Ambient temperature		°C	-15 to +40					
		F	5 to 104					
Lubrication			Lubricated for life					
Direction of rotation			In- and output same direction					
Protection class			IP 69X					
Metal bellows coupling (recommended product type – validate sizing with cymex [®])			-					
Bore diameter of coupling on the application side		mm	-					
Mass moment of inertia (relates to the drive) Clamping hub diameter [mm] Optimized mass inertia version available on request	C	14	J_1	kgcm ²	0.21	0.18	0.16	0.14
				10 ⁻³ in.lb.s ²	0.19	0.16	0.14	0.12
	E	19	J_1	kgcm ²	0.52	0.50	0.47	0.46
				10 ⁻³ in.lb.s ²	0.46	0.44	0.42	0.41

Please use our sizing software cymex[®] for a detailed sizing – www.wittenstein-cymex.com

^{a)} At max. 10 % M_{2KMax}

^{b)} Valid for standard clamping hub diameter

^{c)} Refers to center of the output shaft or flange

^{d)} Please reduce input speed at higher ambient temperatures

View A

View B

2-stage

up to 14⁴⁾ (C)⁵⁾
clamping hub
diameter

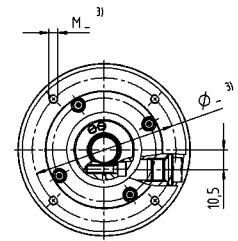
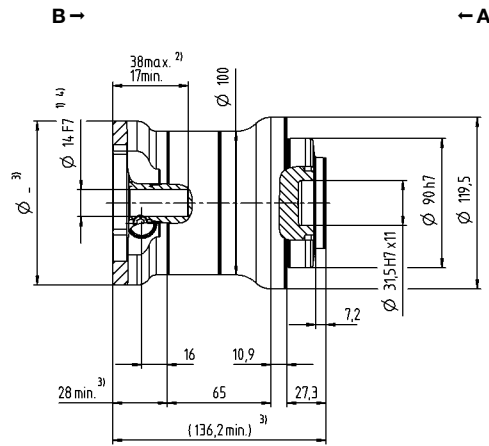
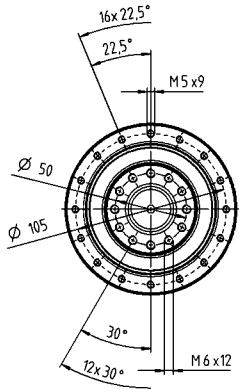

Motor shaft diameter [mm]

up to 19⁴⁾ (E)
clamping hub
diameter

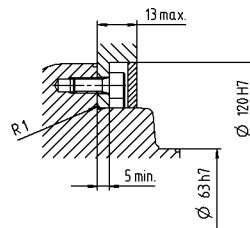
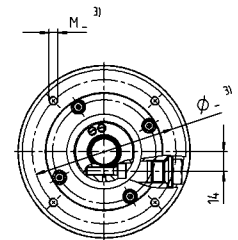
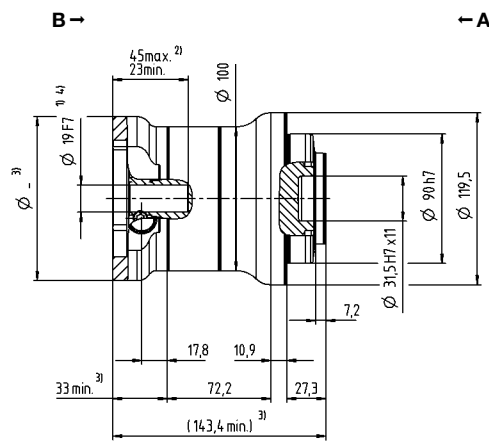
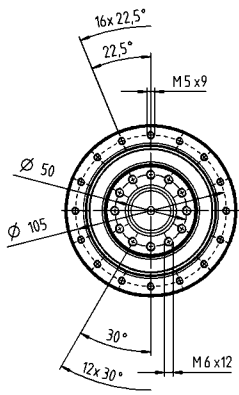

Mounting accessories:
Mounting kit comprising seals and
O-rings available as an option.

Non-tolerated dimensions are nominal dimensions

¹⁾ Check motor shaft fit

²⁾ Min./Max. permissible motor shaft length. Longer motor shafts are possible, please contact alpha.

³⁾ The dimensions depend on the motor

⁴⁾ Smaller motor shaft diameter is compensated by a bushing with a minimum thickness of 1 mm

⁵⁾ Standard clamping hub diameter

HDP+ 025 MA 2-stage

			2-stage					
Ratio	<i>i</i>		22	27.5	38.5	55		
Max. torque ^{a) b)}	T_{2a}	Nm	466	466	466	466		
		in.lb	4128	4128	4128	4128		
Max. acceleration torque ^{b)} (max. 1000 cycles per hour)	T_{2B}	Nm	425	425	425	425		
		in.lb	3762	3762	3762	3762		
Nominal torque (at n_n)	T_{2N}	Nm	312	314	371	413		
		in.lb	2762	2775	3286	3652		
Emergency stop torque ^{a) b)} (permitted 1000 times during the service life of the gearbox)	T_{2Not}	Nm	1200	1200	1200	1200		
		in.lb	10621	10621	10621	10621		
Permitted average input speed (at T_{2a} and 20 °C ambient temperature) ^{d)}	n_{1N}	rpm	3500	3500	3500	3500		
Max. input speed	n_{1Max}	rpm	7500	7500	7500	7500		
Mean no load running torque ^{b)} (at $n_1 = 3000$ rpm and 20 °C gearbox temperature)	T_{012}	Nm	1.0	0.87	0.78	0.70		
		in.lb	9.2	7.7	6.9	6.2		
Max. backlash	j_t	arcmin	≤ 1					
Torsional rigidity ^{b)}	C_{t21}	Nm/arcmin	100	100	100	100		
		in.lb/arcmin	885	885	885	885		
Tilting rigidity	C_{2K}	Nm/arcmin	550					
		in.lb/arcmin	4868					
Max. axial force ^{c)}	F_{2AMax}	N	4800					
		lb _f	1080					
Max. tilting moment	M_{2KMax}	Nm	550					
		in.lb	4868					
Efficiency at full load	η	%	94					
Service life	L_h	h	> 20000					
Weight (incl. standard adapter plate)	m	kg	11.1					
		lb _m	24.5					
Operating noise (at reference ratio and reference speed – ratio-specific values available in cymex [®])	L_{PA}	dB(A)	≤ 58					
Max. permitted housing temperature		°C	+90					
		F	194					
Ambient temperature		°C	-15 to +40					
		F	5 to 104					
Lubrication			Lubricated for life					
Direction of rotation			In- and output same direction					
Protection class			IP 69X					
Metal bellows coupling (recommended product type – validate sizing with cymex [®])			-					
Bore diameter of coupling on the application side		mm	-					
Mass moment of inertia (relates to the drive) Clamping hub diameter [mm] Optimized mass inertia version available on request	E	19	J_1	kgcm ²	0.87	0.70	0.60	0.55
				10 ⁻³ in.lb.s ²	0.77	0.62	0.53	0.49
	G	24	J_1	kgcm ²	2.39	2.22	2.12	2.07
				10 ⁻³ in.lb.s ²	2.12	1.96	1.88	1.83

Please use our sizing software cymex[®] for a detailed sizing – www.wittenstein-cymex.com

^{a)} At max. 10 % M_{2KMax}

^{b)} Valid for standard clamping hub diameter

^{c)} Refers to center of the output shaft or flange

^{d)} Please reduce input speed at higher ambient temperatures

View A

View B

2-stage

up to 19⁴⁾ (E)⁵⁾
clamping hub diameter

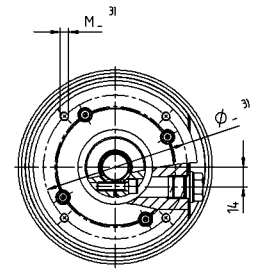
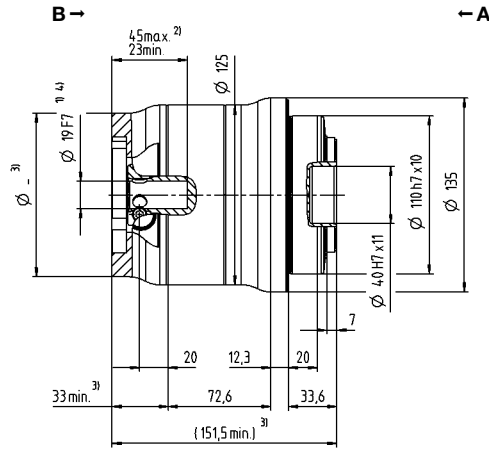
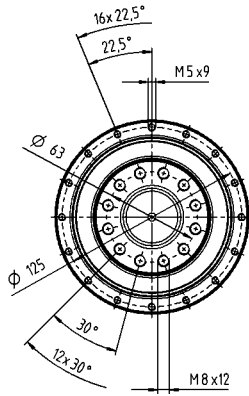

Motor shaft diameter [mm]

up to 24⁴⁾ (G)
clamping hub diameter

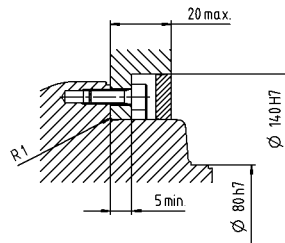
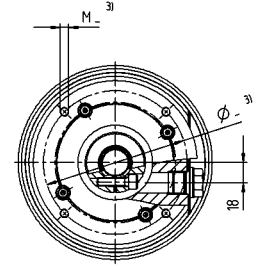
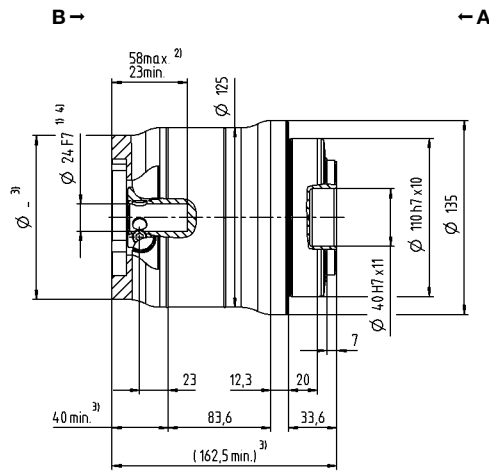
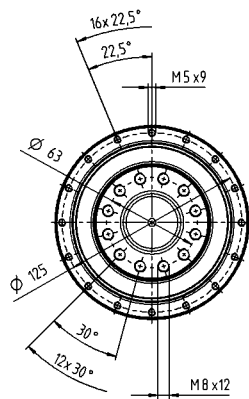

Mounting accessories:
Mounting kit comprising seals and
O-rings available as an option.

Non-tolerated dimensions are nominal dimensions
¹⁾ Check motor shaft fit
²⁾ Min./Max. permissible motor shaft length. Longer motor shafts are possible, please contact alpha.
³⁾ The dimensions depend on the motor
⁴⁾ Smaller motor shaft diameter is compensated by a bushing with a minimum thickness of 1 mm
⁵⁾ Standard clamping hub diameter

HDP+ 050 MA 2-stage

			2-stage					
Ratio	<i>i</i>		22	27.5	38.5	55		
Max. torque ^{a) b)}	T_{2a}	Nm	1121	1121	1121	1121		
		in.lb	9925	9925	9925	9925		
Max. acceleration torque ^{b)} (max. 1000 cycles per hour)	T_{2B}	Nm	795	795	795	795		
		in.lb	7036	7036	7036	7036		
Nominal torque (at n_n)	T_{2N}	Nm	523	566	638	717		
		in.lb	4632	5005	5649	6348		
Emergency stop torque ^{a) b)} (permitted 1000 times during the service life of the gearbox)	T_{2Not}	Nm	2375	2375	2375	2375		
		in.lb	21021	21021	21021	21021		
Permitted average input speed (at T_{2a} and 20 °C ambient temperature) ^{d)}	n_{1N}	rpm	3000	3000	3000	3000		
Max. input speed	n_{1Max}	rpm	6250	6250	6250	6250		
Mean no load running torque ^{b)} (at $n_1 = 3000$ rpm and 20 °C gearbox temperature)	T_{012}	Nm	2.7	2.4	2.1	1.7		
		in.lb	23.9	21.2	18.9	15.0		
Max. backlash	j_t	arcmin	≤ 1					
Torsional rigidity ^{b)}	C_{t21}	Nm/arcmin	210	210	210	210		
		in.lb/arcmin	1859	1859	1859	1859		
Tilting rigidity	C_{2K}	Nm/arcmin	560					
		in.lb/arcmin	4956					
Max. axial force ^{c)}	F_{2AMax}	N	6130					
		lb _f	1379					
Max. tilting moment	M_{2KMax}	Nm	1335					
		in.lb	11816					
Efficiency at full load	η	%	94					
Service life	L_h	h	> 20000					
Weight (incl. standard adapter plate)	m	kg	21.9					
		lb _m	48.4					
Operating noise (at reference ratio and reference speed – ratio-specific values available in cymex [®])	L_{PA}	dB(A)	≤ 60					
			+90					
Max. permitted housing temperature		°C	+90					
		F	194					
Ambient temperature		°C	-15 to +40					
		F	5 to 104					
Lubrication			Lubricated for life					
Direction of rotation			In- and output same direction					
Protection class			IP 69X					
Metal bellows coupling (recommended product type – validate sizing with cymex [®])			-					
Bore diameter of coupling on the application side		mm	-					
Mass moment of inertia (relates to the drive) Clamping hub diameter [mm] Optimized mass inertia version available on request	G	24	J_1	kgcm ²	3.80	3.33	3.00	2.80
				10 ⁻³ in.lb.s ²	3.36	2.95	2.66	2.48
	K	38	J_1	kgcm ²	10.7	10.3	9.90	9.70
				10 ⁻³ in.lb.s ²	9.47	9.12	8.76	8.58

Please use our sizing software cymex[®] for a detailed sizing – www.wittenstein-cymex.com

^{a)} At max. 10 % M_{2KMax}

^{b)} Valid for standard clamping hub diameter

^{c)} Refers to center of the output shaft or flange

^{d)} Please reduce input speed at higher ambient temperatures

View A

View B

2-stage

up to 24⁴⁾ (G)⁵⁾
clamping hub
diameter

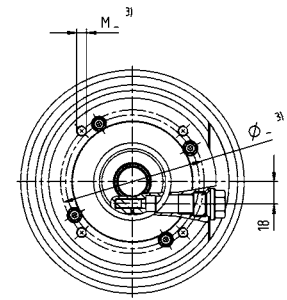
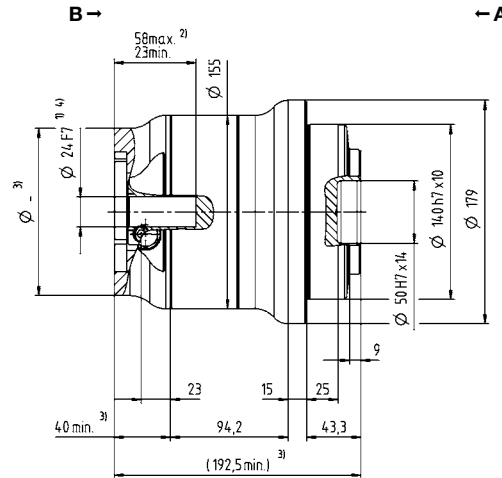
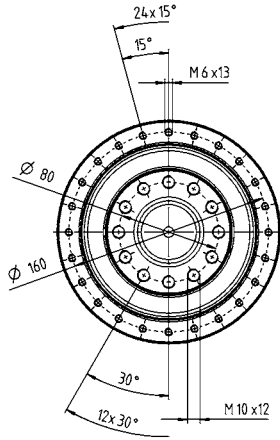

Motor shaft diameter [mm]

up to 38⁴⁾ (K)
clamping hub
diameter

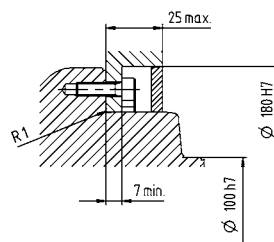
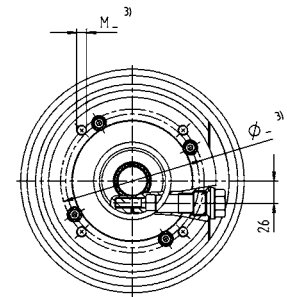
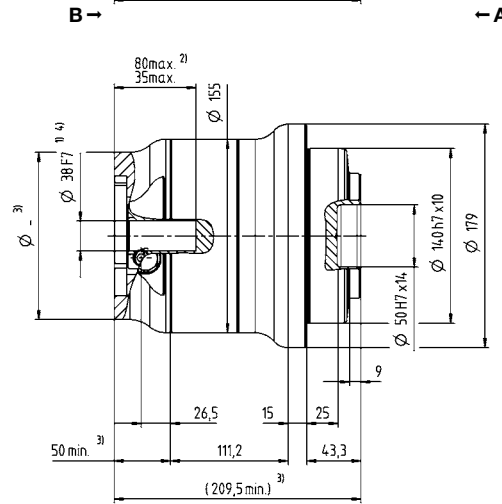
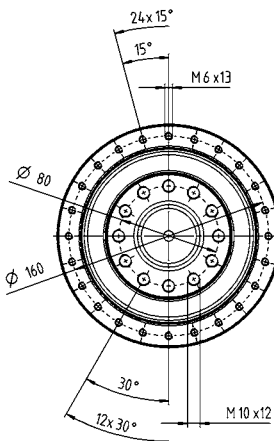

Mounting accessories:
Mounting kit comprising seals and
O-rings available as an option.

Non-tolerated dimensions are nominal dimensions

¹⁾ Check motor shaft fit

²⁾ Min./Max. permissible motor shaft length. Longer motor shafts are possible, please contact alpha.

³⁾ The dimensions depend on the motor

⁴⁾ Smaller motor shaft diameter is compensated by a bushing with a minimum thickness of 1 mm

⁵⁾ Standard clamping hub diameter

Basic Line gearbox overview



Product type		CP	CPS	CPK	CPSK	CVH	CVS
Version		MF	MF	MF	MF	MF / MT	MF / MT
Ratio ^{c)}	min. $i =$	3	3	3	3	7	7
	max. $i =$	100	100	100	100	40	40
Max. torsional backlash [arcmin] ^{c)}	Standard	≤ 12	≤ 12	≤ 13	≤ 15	≤ 15	≤ 15
	Reduced	–	–	–	–	–	–
Output shape							
Smooth shaft		x	x	x	x	–	x
Shaft with key ^{d)}		x	x	x	x	–	x
Splined shaft (DIN 5480)		–	–	–	–	–	–
Blind hollow shaft		–	–	–	–	–	–
Hollow shaft interface		–	–	–	–	x	–
Keyed hollow shaft		–	–	–	–	x	–
Flanged hollow shaft		–	–	–	–	–	–
Flange		–	–	–	–	–	–
System output		–	–	–	–	–	–
Output on both sides		–	–	–	–	x	x
Input type							
Motor-mounted		x	x	x	x	x	x
Self-contained version ^{b)}		–	–	–	–	–	–
Characteristic							
Flange with slotted holes		–	–	–	–	–	–
ATEX ^{a)}		–	–	–	–	–	–
Food-grade lubrication ^{a) b)}		x	x	x	x	x	x
Corrosion resistant ^{a) b)}		–	–	–	–	–	–
Optimized mass inertia ^{a)}		–	–	–	–	–	–
System solutions							
Linear system (rack / pinion)		–	–	–	–	–	–
Servo actuator		–	–	–	–	–	–
Accessories (please refer to the product pages for further options)							
Coupling		x	x	x	x	–	x
Shrink disc		–	–	–	–	x	–

^{a)} Power reduction: technical data available on request

^{b)} Please contact WITTENSTEIN alpha

^{c)} In relation to reference sizes

^{d)} Power reduction: Please use our sizing software cymex® for a detailed sizing – www.wittenstein-cymex.com

Value Line gearbox overview



Product type		NP	NPL	NPS	NPT	NPR	NPK	NPLK	NPSK	NPTK	NPRK	NVH	NVS	HDV
Version		MF / MA	MF / MA	MF / MA	MF / MA	MF / MA	MF	MF	MF	MF	MF	MF	MF	MF / MT
Ratio ^{a)}	min. $i =$	3	3	3	3	3	3	3	3	3	3	4	4	4
	max. $i =$	100	100	100	100	100	100	100	100	100	100	400	400	100
Max. torsional backlash [arcmin] ^{a)}	Standard	≤ 8	≤ 8	≤ 8	≤ 8	≤ 8	≤ 11	≤ 11	≤ 11	≤ 11	≤ 11	≤ 6	≤ 6	≤ 10
	Reduced	-	-	-	-	-	-	-	-	-	-	-	-	-
Output type														
Smooth shaft		x	x	x	-	x	x	x	x	-	x	-	x	x
Shaft with key ^{a)}		x	x	x	-	x	x	x	x	-	x	-	x	x
Splined shaft (DIN 5480)		-	x	x	-	x	-	x	x	-	x	-	-	-
Blind hollow shaft		-	-	-	-	-	-	-	-	-	-	-	-	-
Hollow shaft interface		-	-	-	-	-	-	-	-	-	-	x	-	-
Keyed hollow shaft		-	-	-	-	-	-	-	-	-	-	x	-	-
Flanged hollow shaft		-	-	-	-	-	-	-	-	-	-	-	-	-
Flange		-	-	-	x	-	-	-	-	x	-	-	-	-
System output		-	-	-	-	-	-	-	-	-	-	-	-	-
Output on both sides		-	-	-	-	-	-	-	-	-	-	x	x	-
Input type														
Motor-mounted		x	x	x	x	x	x	x	x	x	x	x	x	x
Self-contained version ^{b)}		-	-	-	-	-	-	-	-	-	-	-	-	-
Characteristic														
Flange with slotted holes		-	-	-	-	x	-	-	-	-	x	-	-	-
ATEX ^{a)}		-	-	-	-	-	-	-	-	-	-	-	-	-
Food-grade lubrication ^{a) b)}		x	x	x	x	x	x	x	x	x	x	x	x	x
Corrosion resistant ^{a) b)}		-	-	-	-	-	-	-	-	-	-	x	x	x
Optimized mass inertia ^{a)}		-	-	-	-	-	-	-	-	-	-	-	-	-
System solutions														
Linear system (rack / pinion)		x	x	x	-	x	x	x	x	-	x	-	x	-
Servo actuator		-	-	-	-	-	-	-	-	-	-	-	-	x
Accessories (please refer to the product pages for further options)														
Coupling		x	x	x	x	x	x	x	x	-	x	-	x	-
Shrink disc		-	-	-	-	-	-	-	-	-	-	x	-	-

^{a)} Power reduction: technical data available on request

^{b)} Please contact WITTENSTEIN alpha

^{c)} In relation to reference sizes

^{d)} Power reduction: Please use our sizing software cymex® for a detailed sizing – www.wittenstein-cymex.com

Advanced Line gearbox overview



Product type		SP+	SP+ HIGH SPEED	SP+ HIGH SPEED friction optimized	TP+	TP+ HIGH TORQUE	HG+	SK+	SPK+
Version		MF	MC	MC-L	MF	MA	MF	MF	MF
Catalog page		26	26	26	80	80	128	140	150
Ratio ^{c)}	min. i =	3	3	3	4	22	3	3	12
	max. i =	100	100	10	100	302.5	100	100	10000
Max. torsional backlash [arcmin] ^{c)}	Standard	≤ 3	≤ 4	≤ 4	≤ 3	≤ 1	≤ 4	≤ 4	≤ 4
	Reduced	≤ 1	≤ 2	≤ 2	≤ 1	–	–	–	≤ 2
Output shape									
Smooth shaft		x	x	x	–	–	–	x	x
Shaft with key ^{d)}		x	x	x	–	–	–	x	x
Splined shaft (DIN 5480)		x	x	x	–	–	–	x	x
Blind hollow shaft		x	x	x	–	–	–	–	x
Hollow shaft interface		–	–	–	–	–	x	–	–
Keyed hollow shaft		–	–	–	–	–	–	–	–
Flanged hollow shaft		–	–	–	–	–	–	–	–
Flange		–	–	–	x	x	–	–	–
System output		–	–	–	x	x	–	–	–
Output on both sides		–	–	–	–	–	x	x	x
Input type									
Motor-mounted		x	x	x	x	x	x	x	x
Self-contained version ^{b)}		x	–	–	x	–	–	–	–
Characteristic									
Flange with slotted holes		x	–	–	–	–	–	–	–
ATEX ^{a)}		x	x	–	–	–	x	x	–
Food-grade lubrication ^{a) b)}		x	x	x	x	x	x	x	x
Corrosion resistant ^{a) b)}		x	x	x	x	x	x	x	x
Optimized mass inertia ^{a)}		x	x	x	x	x	–	–	–
System solutions									
Linear system (rack / pinion)		x	x	–	x	x	–	x	x
Servo actuator		x	–	–	x	x	–	–	–
Accessories (please refer to the product pages for further options)									
Coupling		x	x	x	x	x	–	x	x
Shrink disc		x	x	x	–	–	x	–	x

^{a)} Power reduction: technical data available on request

^{b)} Please contact WITTENSTEIN alpha

^{c)} In relation to reference sizes

^{d)} Power reduction: Please use our sizing software cymex[®] for a detailed sizing – www.wittenstein-cymex.com



TK+	TPK+	TPK+ HIGH TORQUE	SC+	SPC+	TPC+	VH+	VS+	VT+	DP+	HDP+
MF	MF	MA	MF	MF	MF	MF	MF	MF	MF / MA	MA
178	188	188	228	238	248	262	272	280	292	308
3	12	66	1	4	4	4	4	4	16	22
100	10000	5500	2	20	20	400	400	400	55	55
≤ 4	≤ 4	≤ 1.3	≤ 4	≤ 4	≤ 4	≤ 3	≤ 3	≤ 3	≤ 3	≤ 1
-	≤ 2	-	-	≤ 2	≤ 2	≤ 2	≤ 2	≤ 2	≤ 1	-

-	-	-	x	x	-	-	x	-	-	-
-	-	-	x	x	-	-	x	-	-	-
-	-	-	-	x	-	-	x	-	-	-
-	-	-	-	x	-	-	-	-	-	-
-	-	-	-	-	-	x	-	-	-	-
-	-	-	-	-	-	x	-	-	-	-
x	-	-	-	-	-	-	-	x	-	-
-	x	x	-	-	x	-	-	-	x	x
-	x	x	-	-	x	-	-	-	-	-
x	x	x	-	-	-	x	x	-	-	-

x	x	x	x	x	x	x	x	x	x	x
-	-	-	-	-	-	-	-	-	-	-

-	-	-	-	-	-	-	-	-	-	-
x	-	-	-	-	-	-	-	-	-	-
x	x	x	x	x	x	x	x	x	x	x
x	x	x	-	-	-	x	x	x	x	x
-	-	-	-	-	-	-	-	-	x	x

x	x	x	x	x	x	-	x	x	-	-
-	-	-	-	-	-	-	-	-	-	-

x	x	x	x	x	x	-	x	x	-	-
-	-	-	-	x	-	x	-	-	-	-

Premium Line gearbox overview



Product type		XP+	RP+	XPK+	RPK+	XPC+	RPC+
Version		MF / MC	MF / MA	MF	MA	MF	MA
Ratio ^{c)}	min. $i =$	3	22	12	48	4	22
	max. $i =$	100	220	1000	5500	20	55
Max. torsional backlash [arcmin] ^{c)}	Standard	≤ 3	≤ 1	≤ 4	≤ 1.3	≤ 4	≤ 1.3
	Reduced	≤ 1	–	≤ 2	–	≤ 2	–
Output shape							
Smooth shaft		x	–	x	–	x	–
Shaft with key ^{d)}		x	–	x	–	x	–
Splined shaft (DIN 5480)		x	–	x	–	x	–
Blind hollow shaft		x	–	x	–	x	–
Hollow shaft interface		–	–	–	–	–	–
Keyed hollow shaft		–	–	–	–	–	–
Flanged hollow shaft		–	–	–	–	–	–
Flange		–	x	–	x	–	x
System output		x	x	x	x	x	x
Output on both sides		–	–	–	–	–	–
Input type							
Motor-mounted		x	x	x	x	x	x
Self-contained version ^{b)}		x	–	–	–	–	–
Characteristic							
Flange with slotted holes		x	x	x	x	x	x
ATEX ^{a)}		–	–	–	–	–	–
Food-grade lubrication ^{a) b)}		x	x	x	x	x	x
Corrosion resistant ^{a) b)}		–	–	–	–	–	–
Optimized mass inertia ^{a)}		x	x	–	–	–	–
System solutions							
Linear system (rack / pinion)		x	x	x	x	x	x
Servo actuator		x	x	–	–	–	–
Accessories (please refer to the product pages for further options)							
Coupling		x	–	x	–	x	–
Shrink disc		x	–	x	–	x	–

^{a)} Power reduction: technical data available on request

^{b)} Please contact WITTENSTEIN alpha

^{c)} In relation to reference sizes

^{d)} Power reduction: Please use our sizing software cymex[®] for a detailed sizing – www.wittenstein-cymex.com

Overview of gearbox variants

SP 100 S - MF 1 - 10 - 0G 1 - 2S

Characteristic:

B = Modular output combination
C = Reverse centering
E = ATEX
F = Food grade lubrication
G = Grease
H = Food-grade grease
L = Friction optimized
R = Flange with slotted holes
S = Standard
W = Corrosion resistant

Explanation of variants deviating from the standard:

B = Modular output combination

An additional backward output type is available for hypoid gearboxes. See page 353 for details.

C = Reverse centering

To save space, this variant offers greater flexibility in mounting the product on the machine.

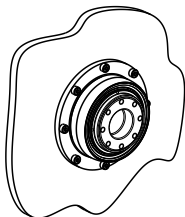

E = ATEX

Devices bearing the Ex symbol comply with EU Directive 2014/34/EN (ATEX) and are approved for use in defined explosion-prone zones. Performance data is limited and can be found in the operating instructions.

F = Food grade lubrication

These products are available with food-grade lubrication and can therefore be used in the food industry. Please note that the torque ratings in the catalog are reduced by 20 % (excluding V-Drive).

G = Grease

This variant allows you to lubricate selected products with grease instead of oil. Please note that the torque ratings in the catalog are reduced by 20 %.

H = Food-grade grease

This variant allows you to lubricate selected products with food-safe grease instead of oil. Please note that the torque ratings in the catalog are reduced by 40%.

L = Friction optimized

A friction-optimized variant is available for HIGH SPEED products.

Design changes allow the products to be used particularly in applications with high temperature sensitivity, high nominal speeds or long duty cycles.

R = Flange with slotted holes

This output type is designed for linear applications with rack and pinion or belt pulley. Integrated slotted holes enable easy positioning of the pinion or simple tensioning of the belt.

W = Corrosion resistant

These products can be used in corrosive environments, e.g. in the food industry, pharmaceutical industry or packaging industry. All external product areas have been designed to avoid corrosion. In addition the products are provided with food-grade grease lubrication. Please note that the torque ratings in the catalog are reduced by 20 % (excluding V-Drive).

alpha Advanced Linear Systems

Strong performance in the advanced segment

Advanced Linear Systems are adapted to applications with average to high demands in terms of smooth running, positioning accuracy and feed force. Different gearbox versions and options such as HIGH TORQUE or HIGH SPEED can be selected to utilize the most appropriate system for the application. Typical fields of application include wood, plastic and composite machining, machining centers and automation.

The alpha preferred linear system – The best of each segment

Our preferred linear systems in the Advanced Segment are always comprised of the perfect combination of gearbox, pinion, rack and lubrication system. The systems are optimized to achieve the required feed force, feed speed, rigidity and degree of utilization of the individual components.



For further information, refer to our alpha Linear Systems catalog and our website:
www.wittenstein-alpha.com/linear-systems

For a wide range of applications

Linear systems from WITTENSTEIN alpha are suitable for a wide range of applications and industries. New standards and advantages have been achieved in the following areas:

- Smooth operation
- Positioning accuracy
- Feed force
- Power density
- Rigidity
- Easy installation
- Design options
- Scalability

Together with a comprehensive range of services, we pledge to support you from the initial concept to the design, installation and commissioning phase. We will also ensure a consistent supply of spare parts.

Your benefits at a glance

Perfectly adapted linear systems available with planetary, right-angle and worm gearboxes or as an actuator

Optionally with INIRA®

Large individual configuration range due to numerous pinion/gearbox combinations



INIRA®: The revolution in rack assembly



Simply scan the QR code using your smartphone to see INIRA® in action.

INIRA® combines our existing innovative concepts for the simple, safe and efficient installation of racks. INIRA® clamping, INIRA® adjusting and INIRA® pinning have already made the assembly process much faster, more accurate and more ergonomic. Available for the Advanced and Premium Linear Systems.

INIRA® clamping: Simply faster and more ergonomic
Previously, enormous effort was required to clamp racks to the machine bed using screw clamps. INIRA® clamping integrates the clamping device in the rack. The rack incorporates a mounting sleeve which is guided over the head of the fastening screw to ensure quick and ergonomic clamping.

INIRA® pinning: Simply better and more efficient
The previous method used for pinning racks was extremely time-consuming. Precision bores have to be drilled and the chips generated must be carefully removed from the assembly. INIRA® pinning now offers a completely new solution for the chipless pinning of racks, which reduces installation times considerably (time spent on each rack ~ 1 min).

INIRA® adjusting: Simply safer and more precise
In combination with INIRA® clamping, INIRA® adjusting is the ideal solution for perfectly adjusting the transition between two rack segments. The innovative setting tool can adjust the transition extremely reliably and precisely, accurate to the micrometer.



INIRA® clamping



INIRA® adjusting



INIRA® pinning

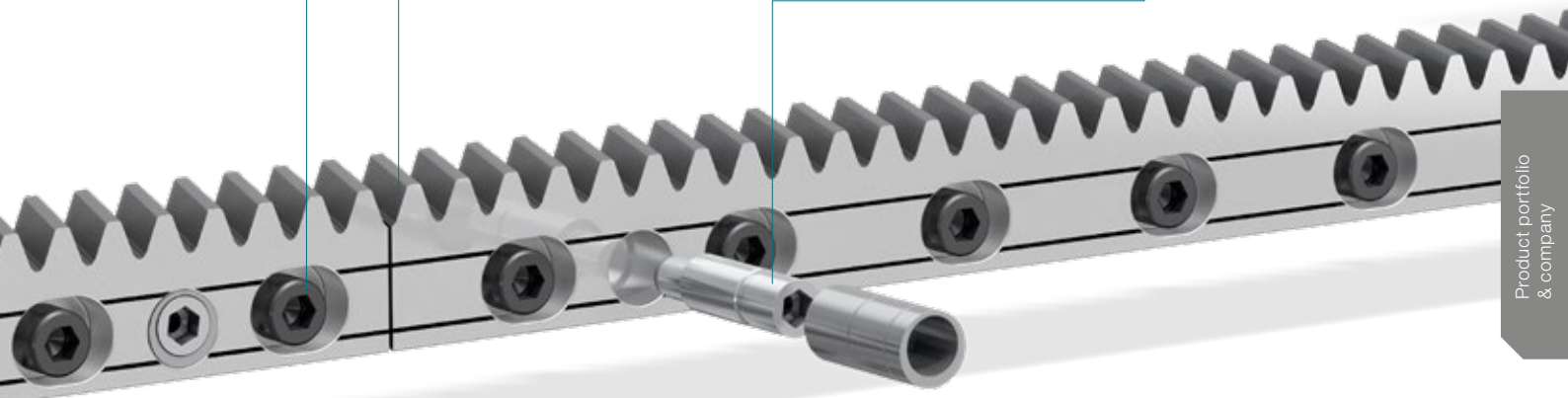

Precision meets motion = premo® by WITTENSTEIN alpha

premo® is a new, powerful servo actuator platform that combines absolute precision with perfect movement. The central idea behind this first fully scalable servo actuator platform is uncompromising flexibility from the viewpoint of the user. Motors and gearboxes with application-related graduated performance characteristics can be configured modularly to individual servo actuators. The result is a

highly versatile modular system with customizable power, designed for a wide variety of applications. The core of the servo actuator is a torsionally rigid precision gearbox with low backlash and excellent torque density combined with the equally powerful, permanent magnet servo motor with a split winding that guarantees low cogging and minimal velocity ripple.

premo® – clearly superior in performance

- Higher machine performance thanks to higher acceleration torque
- High torque density combined with a compact design allow for the realization of higher performance machines with significant space saving
- Improved connectivity to next generation controllers from leading system providers through the use of digital feedback (EnDat 2.2, DSL, HIPERFACE DSL®, DRIVE-CLiQ)
- Compatibility for high bus voltages up to 750 V DC
- Reduced wiring requirement through single-connector technology
- Improved reliability and safety through the use of more powerful brakes and SIL 2 encoders



Product highlights

- Optimized power density for greater energy efficiency and productivity
- Flexible mechanical and electrical interfaces for high scalability
- Variety of options for individually upgrading the basic configuration

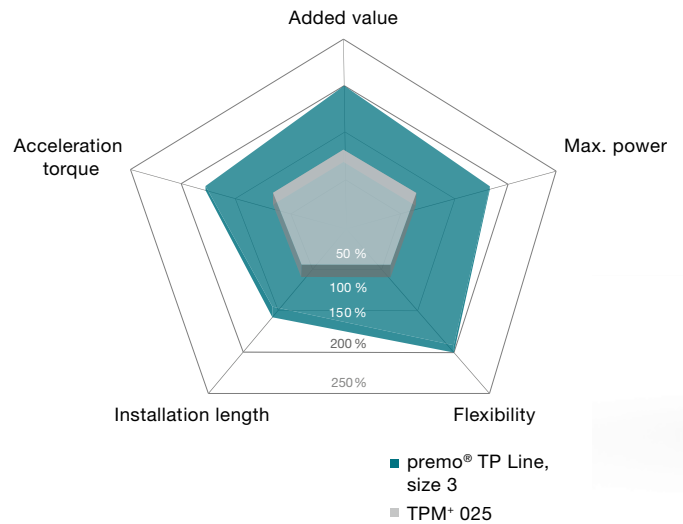

premo® application examples



Handling portal
premo® SP Line

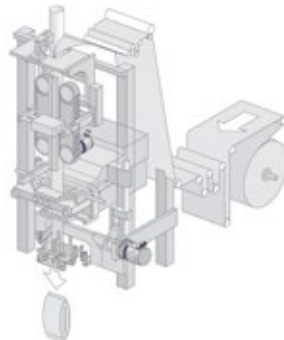

Fill and Seal machine
premo® TP Line

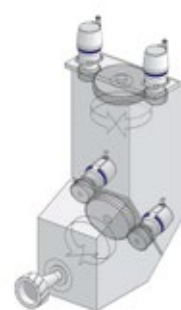

Milling cutter for a machining center
premo® XP Line

Typical fields of application and industry solutions

- Delta robot (axes 1–3, swivel axis)
- Handling portal (Z-axis, swivel/rotating axis)
- Machine tool reaming (rotating axes A–C, tool changer)
- Fill and Seal Machine (incl. jaw stroke, sealing jaw, blade)
- Folding carton packaging (incl. assembly/folding, filling valve)
- Plastic thermoform (tool axis)

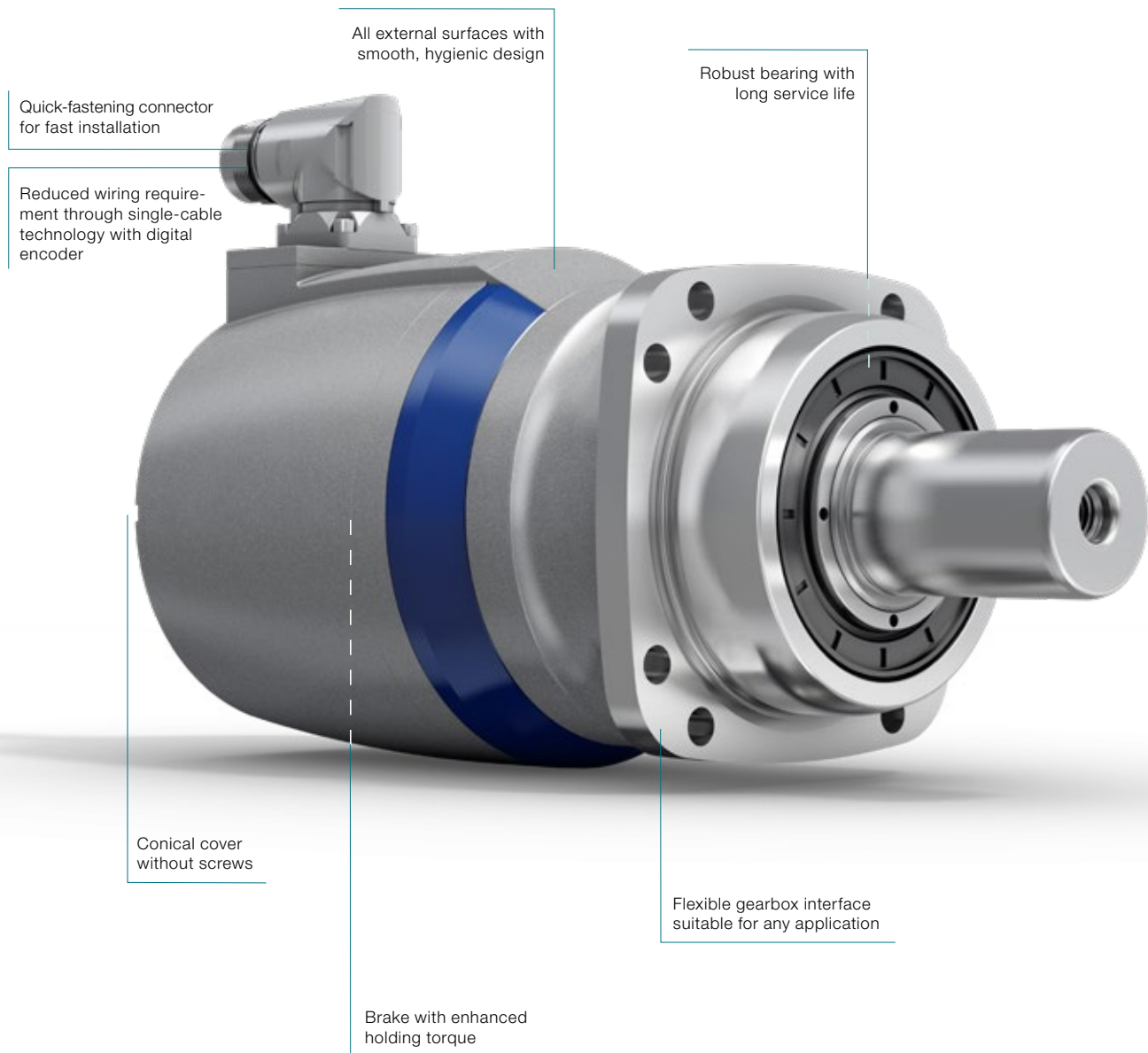

Accessories – smart additions for intelligent performance

Gearboxes, accessories and consulting from a single source

Optimization of your added value chain
Use the combination of gearbox and accessories in a complete package to streamline your internal processes.

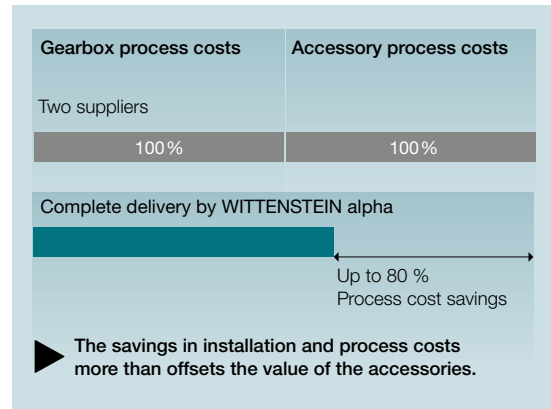
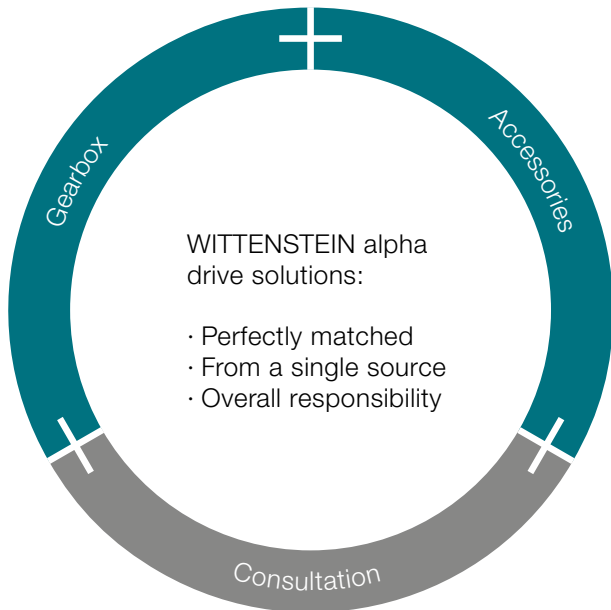

Shrink disks

Shrink disks are frictional hub / shaft connections. Together with our hollow shaft or mounted shaft gearboxes for mounting directly on load shafts, machines can be designed to take up a minimal installation space.

The benefits:

- Simple mounting and removal
- Quick selection, easy and convenient
- Optional: corrosion resistant version



Preferred shrink disk series

To view a wide range of nickel-plated, stainless steel and other shrink disks as well as all the relevant technical data and dimensions, visit our homepage www.wittenstein-alpha.com

Couplings

Couplings are used for compensating misalignment during assembly and material-related heat expansion

Compensation for shaft misalignment

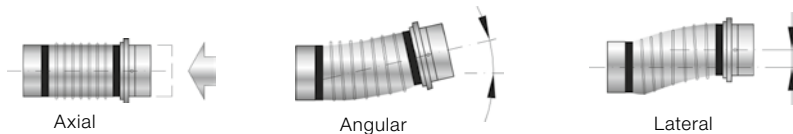

Metal bellows coupling

- Compensation for shaft misalignment
- Completely backlash free
- Corrosion resistant version available as an option (BC2, BC3, BCT)
- High torsional rigidity



Elastomer coupling

- Compensation for shaft misalignment
- Completely backlash free
- Selectable torsional rigidity/damping
- Compact design
- Extremely simple installation (plug-in)



Torque limiter

- Compensation for shaft misalignment
- Completely backlash free
- Precise, preset overload protection (switch-off in 1 – 3 ms)
- Precise repeat accuracy
- Just one protection element per axis

Preferred coupling series

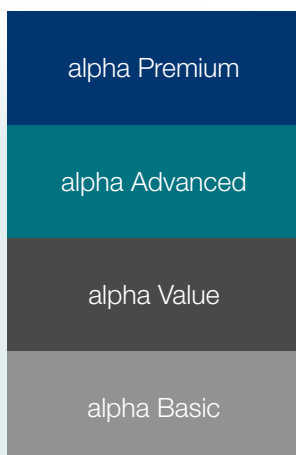

Preferred series are defined for the relevant gearbox segments to make selection easier. Preferred couplings are defined based on the maximum torque that the gearbox can transmit. Standard industrial conditions for the number of cycles (1000/h) and ambient temperature were adopted.

Please note that the coupling load is based on the torque that the gearbox can transmit and not the torque in your application. We recommend using our cymex®5 design software to create a more detailed design. (www.wittenstein-cymex.com)

For more coupling types, please visit www.wittenstein-alpha.com

Support at each interaction stage

With the WITTENSTEIN alpha service concept, we are also setting new standards in the field of customer support.

Global presence

Our global consultation network will help you overcome your complex challenges through our extensive experience, a variety of design tools and individual engineering services.

Speed counts

Our speedline® team guarantees fast response times in the area of logistics. We provide on-site support during the installation and commissioning of mechanical systems to give you a sustained competitive edge.

Personal consultation

Our highly qualified and committed expert personnel will accompany you throughout the entire product lifecycle - around the clock. When it comes to customer support, you can count on us!

Design

Consultation
CAD POINT
SIZING ASSISTANT
Sizing software cymex®
Engineering

Installation

speedline® delivery
Installation on-site
Operating & installation instructions
Pick-up & return service



We are happy to advise you:

24 h service hotline: +49 7931 493-12900

No matter where you need us:

A comprehensive sales and service network provides quick availability and competent support worldwide.

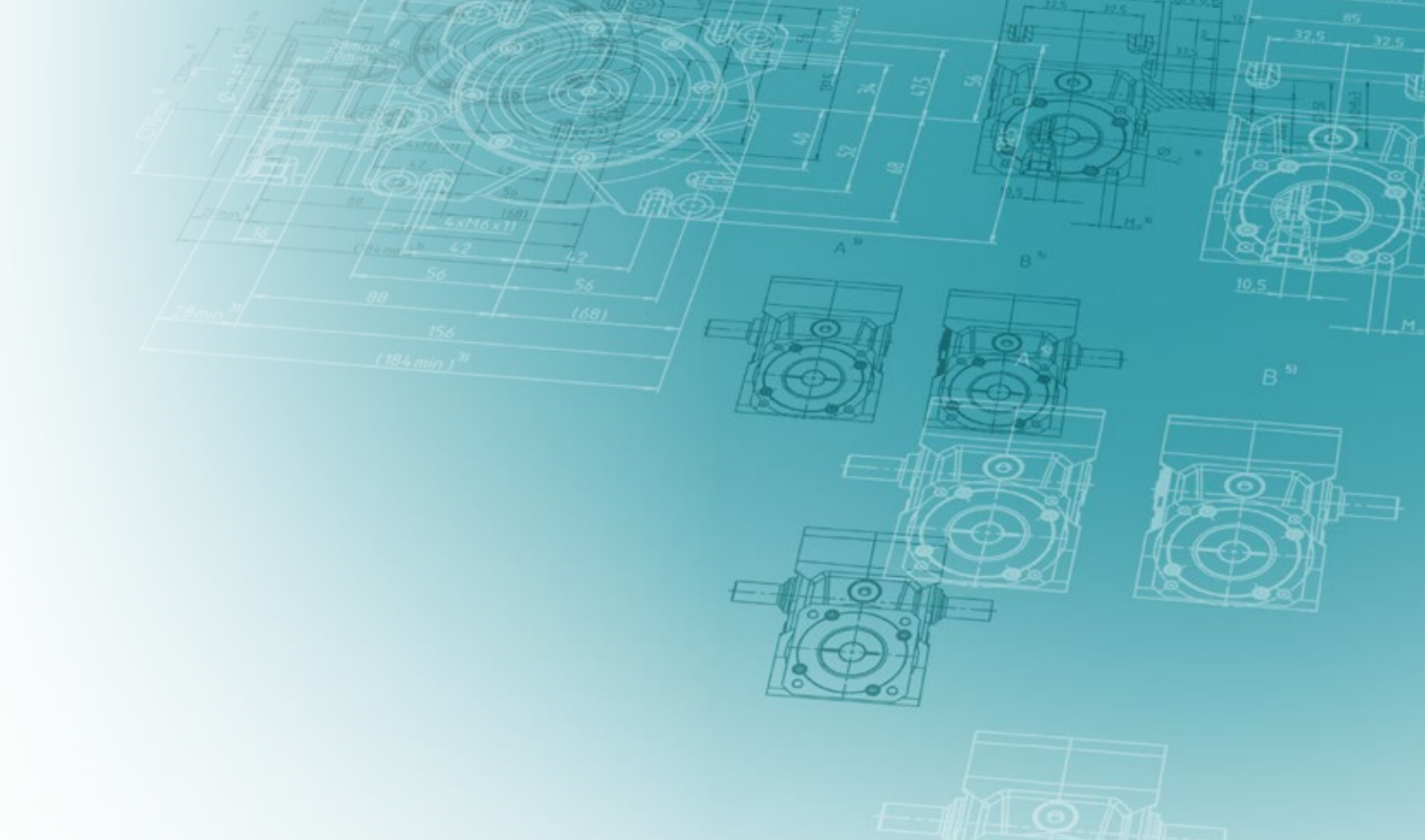

Maintenance

24 h service hotline
Maintenance and inspection
Repair
cymex® statistics
Modernization

Training

Product training
Sizing training
Installation training
Service training

Support at each interaction stage

Design

Whatever your requirements are: we offer the right design methodology. Use the CAD POINT to gain easy access to CAD files, the SIZING ASSISTANT for creating simple

designs, cymex® 5 for precise dimensioning and our engineering service for individual solutions.

Consultation

- Personal contact on-site
- Professional application calculations and drive design create the best solutions



CAD POINT

- 3D data of selected solution
- Online comparison with motor geometry
- Transparent and simple selection of required components

Engineering

Catalog gearboxes:

- Advanced software tools for accurate calculation, simulation and analysis of the drive train
- Optimization of your productivity and reduction in development costs



SIZING ASSISTANT

- Efficient online design within seconds
- Convenient comparison function
- Automatic geometry adjustment

Special gearboxes:

- Gearing design and development
- Development and production of special gearboxes
- Send all inquiries to: sondergetriebe@wittenstein.de



cymex® 5 sizing software

- Dimensioning, design and evaluation of the entire drive train
- Reliable, efficient design
- Optimization of drive system



Installation

All delivered products are perfectly matched to your application environment and fully operational right away.

Our service experts support you in the installation and commissioning of complex mechatronic systems, guaranteeing maximum availability of your plant.

speedline® delivery

Tel. +49 7931 493-10444

- Delivery of standard series in 24 or 48 hours ex works*
- Outstanding flexibility for fast deliveries at short notice

Operating and installation instructions

- Detailed explanations of how to use the product
- Motor installation videos
- Assembly videos on rack and pinion system

Installation on-site

- Professional installation
- Optimal integration of the system in your application
- Explanation of the drive function

Pick-up and return service

- Cost savings through minimization of downtimes
- Professional logistics organization
- Reduction of transport risks through customized, direct pick-up and delivery



* Non-binding delivery time depending on part availability.

Support at each interaction stage

Maintenance

WITTENSTEIN alpha guarantees fast repairs of the highest quality and precision – with short throughput times and intensive support. In addition, we will provide you with information about various measurements, material

analyses and condition monitoring inspections. You can rely on short response times, unbureaucratic processing and individual support.

24 h service hotline

Tel. +49 7931 493-12900

- Available round the clock
- Personal, prompt service for resolving time-critical maintenance issues

cymex® statistics

- Systematic field data acquisition
- Reliability calculations (MTBF)
- Customized evaluations

Maintenance and inspection

- Documentation regarding condition and expected service life
- Maintaining required state
- Customized maintenance schedules

Modernization

- Professional retrofitting
- Reliable compatibility testing of existing solutions

Repair

- Restoring to required state
- Short throughput times
- Immediate response in time-critical situations



Training

Discover how our products function and how they can add value to your application. We offer you training courses at our premises or on-site at your plant. Benefit from

practice-oriented learning methods and a highly skilled team of trainers.

Product training

Greater knowledge enables greater achievement. We will be pleased to share our expert knowledge with you: Profit from our many years of experience and learn more about the product portfolio of WITTENSTEIN alpha.

Sizing training

Become a design expert! We will provide you with training courses on our design software, adapted to your requirements. Whether for beginners or experts, for occasional or regular users – we adapt our training course to your wishes and requirements.

Installation training

We offer you individual training courses on-site for your system application of selected linear axes as well as professional installation.

Service training

Participation in a service training course is a prerequisite for sourcing spare parts at the parts list level. We offer you training courses at our premises or on-site at your plant. Moreover, we regularly host maintenance workshops at which the participants are instructed in safe handling during mounting of the motor to the gearbox as well as the independent replacement of wearing parts and gearbox assemblies.



The WITTENSTEIN group – The company and its fields of business



WITTENSTEIN

With approximately 2,900 employees worldwide, WITTENSTEIN SE stands for innovation, precision and excellence in the world of mechatronic drive technology, both nationally and internationally. The group is active in seven innovative fields of business. Furthermore, WITTENSTEIN SE is represented by some 60 subsidiaries in around 40 countries in all important technology and sales markets worldwide.



Our fields of expertise

We provide know-how for a host of different sectors:

- Machine and plant construction
- Software development
- Aerospace
- Automotive & E-mobility
- Energy
- Oil & Gas Exploration and Production
- Medical technology
- Measurement and testing technology
- Nanotechnology
- Simulation

The WITTENSTEIN Group



WITTENSTEIN alpha GmbH
High-precision servo drives and linear systems



WITTENSTEIN cyber motor GmbH
Highly dynamic servo motors and drive electronics



WITTENSTEIN galaxie GmbH
Superior gearboxes and drive systems

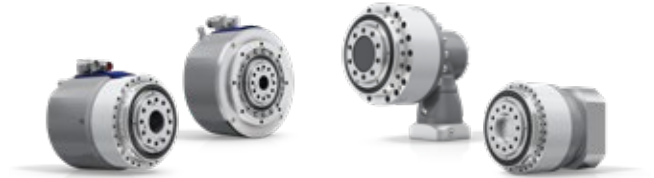

WITTENSTEIN motion control GmbH
Customized linear and rotary servo systems



WITTENSTEIN aerospace & simulation GmbH
Mechatronic drive systems for aerospace & simulation



attocube systems AG
Nanoprecision drive and measurement technology solutions



baramundi software AG
Secure management of IT infrastructure in offices and production areas



Gearbox general – Detailed sizing

Cyclic operation **S5** and continuous operation **S1**

Calculate the duty cycle ED

$$ED = \frac{(t_b + t_c + t_d)}{(t_b + t_c + t_d + t_e)} \cdot 100$$

$$ED = t_b + t_c + t_d$$

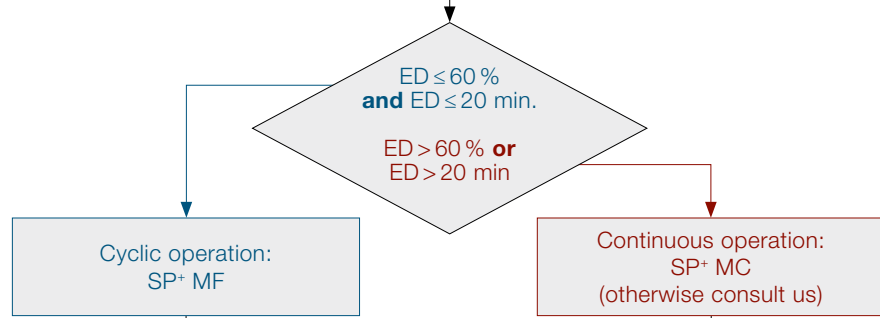

$$Z_n = \frac{3600}{(t_b + t_c + t_d + t_e)} \quad \text{see diagram 1}$$

f_s is dependent on Z_n see diagram 2

T_{2b} depends on the application

$$T_{2b, fs} = T_{2b} \cdot f_s$$

$$f_0 = \frac{t_{\alpha 1} + \dots + t_{\alpha n}}{t_{ges}}$$

t_α = elevation time
 t_α = operating time with

$$T_{2b, fs} \geq T_{2B}$$

$$n_{2m} = \frac{|n_{2b}| \cdot t_b + \dots + |n_{2n}| \cdot t_n}{t_b + \dots + t_n} \quad \text{incl. pause time}$$

$$n_{2m\alpha} = \frac{|n_{2\alpha 1}| \cdot t_{\alpha 1} + \dots + |n_{2\alpha n}| \cdot t_{\alpha n}}{t_{\alpha 1} + \dots + t_{\alpha n}}$$

$$f_\alpha = n_{2m\alpha} \cdot L_h \cdot f_0$$

L_h = required service life

i depends on
 - required output speed (for the application)
 - reasonable input speed (gearbox / motor)

$$n_{1max} = n_{2max} \cdot i$$

$$n_{1max} \leq n_{1Mot max}$$

T – consisting of corresponding output and input torque

$$T_{1b} = T_{2b} \cdot \frac{1}{i} \cdot \frac{1}{\eta} \quad T_{1b} \leq T_{Mot max}$$

λ – from resulting inertia ratio.
 Guide value: $1 \leq \lambda \leq 10$
 (see alphabet for calculation)

n_{2max} depends on the application

Calculate the number of cycles Z_n

Calculate the shock factor f_s see diagram 2

Calculate the max. acceleration torque at the output including the shock factor $T_{2b, fs}$

Calculate the elevation range f_0

Calculate the average elevation speed $n_{2m\alpha}$

Calculate the relevant output shaft revolutions f_α

Calculate of $T_{2\alpha, zul}$ see diagramm 3

$$T_{2b, fs} \leq T_{2\alpha, zul}$$

no Select a larger gearbox or please consult

yes

Calculate the max. output speed n_{2max} see diagram 1

Calculate the ratio i

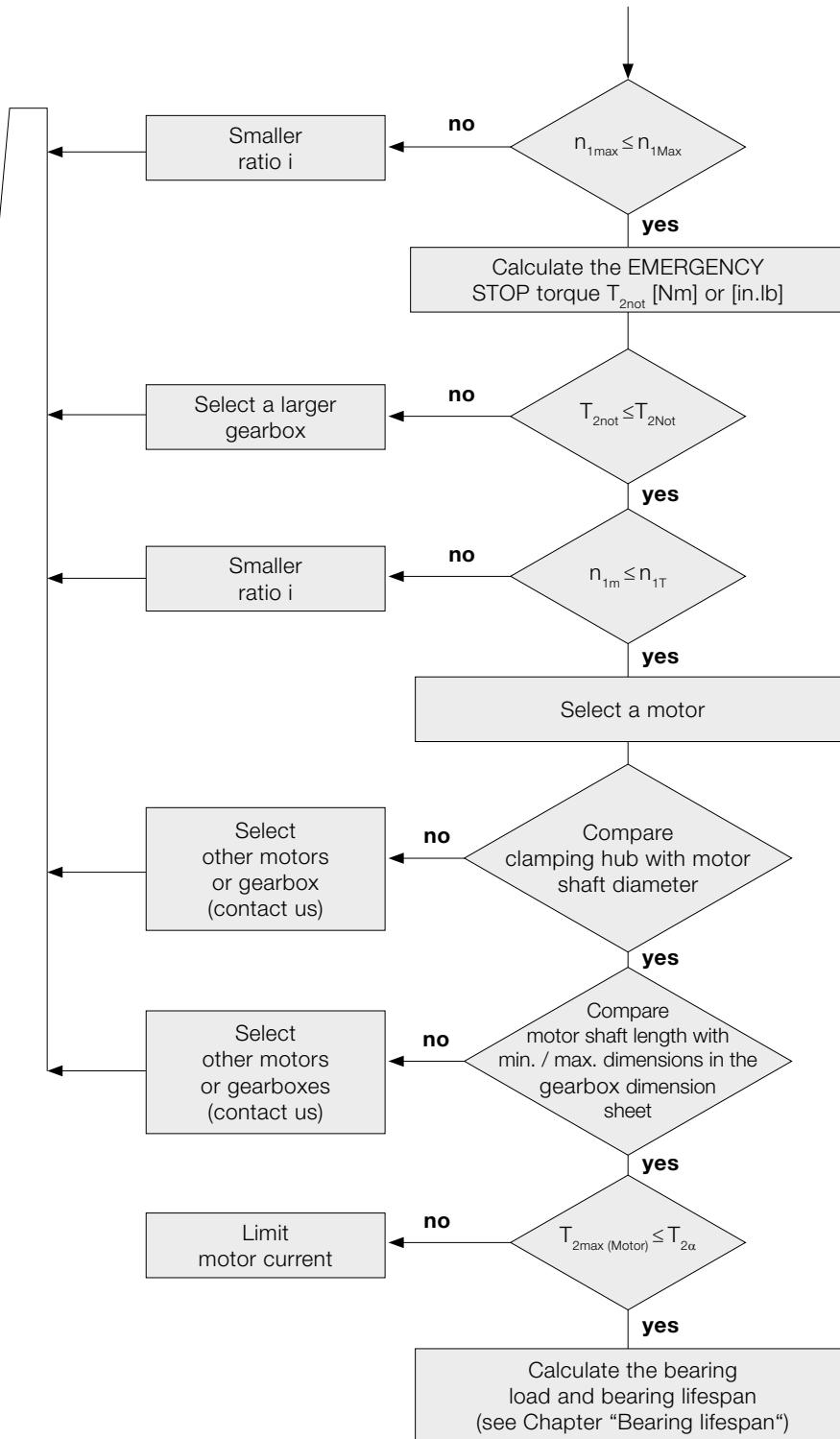

Please refer to the relevant technical data for information on the max. permissible characteristic values for your gearbox.

T_{2not} depends on the application

$$n_{1m} = n_{2m} \cdot i$$

$$D_{W, Mot} \leq D_{clamping\ hub}$$

The motor shaft must be inserted far enough into the clamping hub.

The motor shaft must protrude far enough into the clamping hub without making contact.

$$T_{2max (Motor)} = T_{1max (Motor)} \cdot i \cdot \eta_{gearbox}$$

The gearbox should not be damaged when the motor operates at full load, limit the motor current if necessary.

Diagram 1
Standard collective load at output. At input speeds up to rated speed n_{IN} or thermal speed limit n_{1T} , the temperature of the gearbox will not exceed 90 °C under average ambient conditions.

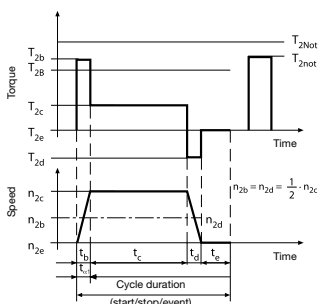

Diagram 2
Large number of cycles combined with short acceleration times may cause the drive train to vibrate. Use the shock factor f_s to include the resulting excess torque values in calculations.

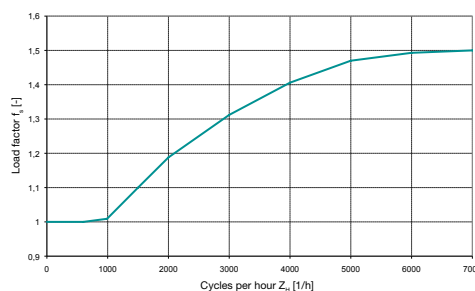
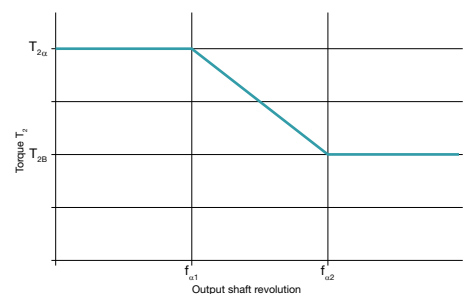
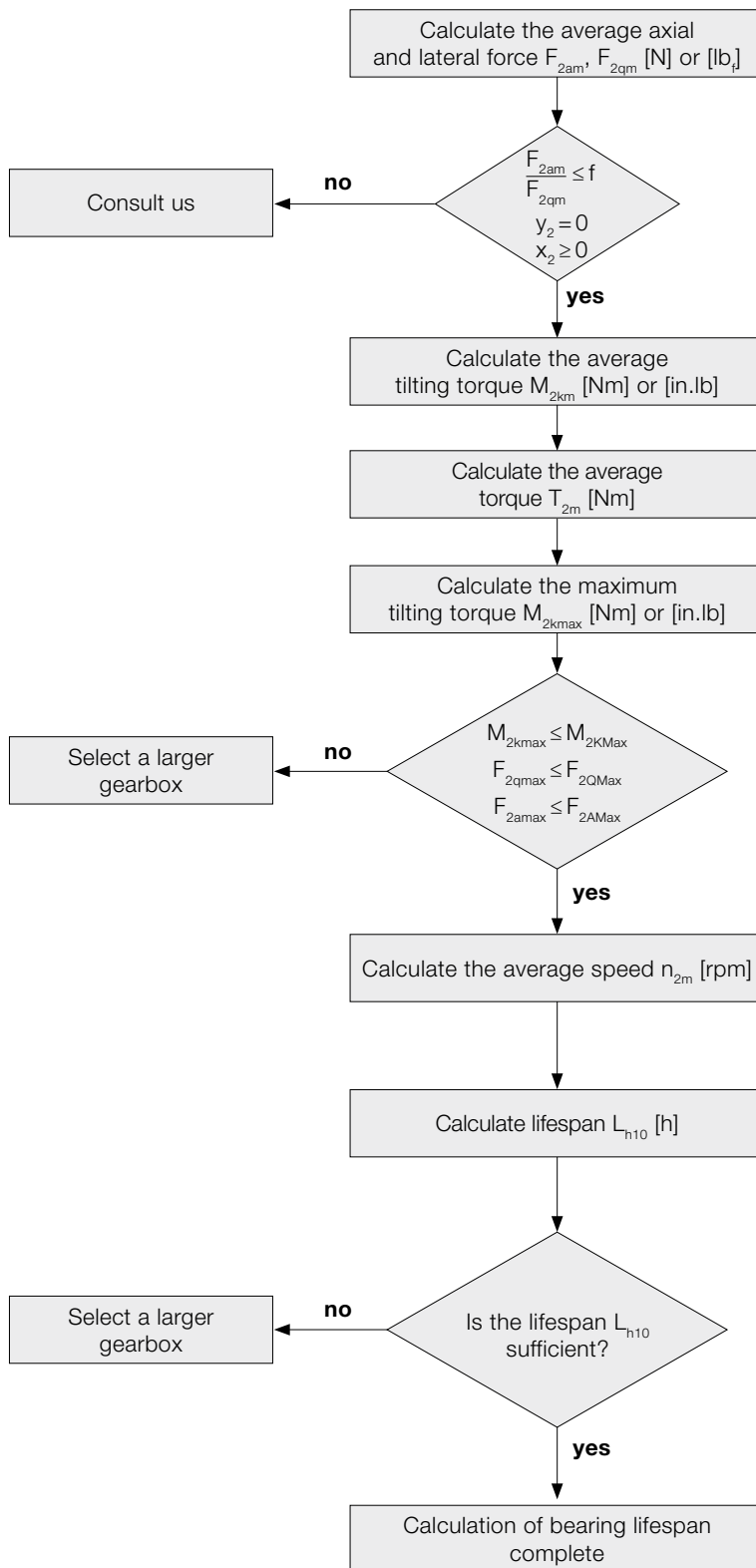

Diagram 3
The transmittable torque $T_{2u,per}$ of the gearbox is dependent on the number of output shaft revolutions. In the lower output shaft revolution range, the fatigue strength range of the toothing can be fully utilized up to the maximum value T_{2u} .



Gearbox general – Detailed sizing

Bearing lifespan L_{h10}



$$F_{2am} = \sqrt[3]{\frac{|n_{2b}| \cdot t_b \cdot |F_{2ab}|^3 + \dots + |n_{2n}| \cdot t_n \cdot |F_{2an}|^3}{|n_{2b}| \cdot t_b + \dots + |n_{2n}| \cdot t_n}}$$

$$F_{2qm} = \sqrt[3]{\frac{|n_{2b}| \cdot t_b \cdot |F_{2qb}|^3 + \dots + |n_{2n}| \cdot t_n \cdot |F_{2qn}|^3}{|n_{2b}| \cdot t_b + \dots + |n_{2n}| \cdot t_n}}$$

$$M_{2km} = \frac{F_{2am} \cdot y_2 + F_{2qm} \cdot (x_2 + z_2)^a}{W}$$

$$T_{2m} = \sqrt[3]{\frac{|n_{2b}| \cdot t_b \cdot |T_{2b}|^3 + \dots + |n_{2n}| \cdot t_n \cdot |T_{2n}|^3}{|n_{2b}| \cdot t_b + \dots + |n_{2n}| \cdot t_n}}$$

$$M_{2kmax} = \frac{F_{2amax} \cdot y_2 + F_{2qmax} \cdot (x_2 + z_2)^a}{W}$$

^{a)} x, y, z in mm

$$n_{2m} = \frac{n_{2b} \cdot t_b + \dots + n_{2n} \cdot t_n}{t_b + \dots + t_n}$$

$$L_{h10} = \frac{16666}{n_{2m}} \cdot \left[\frac{K1_2}{M_{2km}} \right]^{p_2}$$

	metric	inch
W	1000	1

	TP ⁺ /TPK ⁺	SP ⁺ /SPK ⁺
f	0.37	0.40

Example with output shaft and flange:

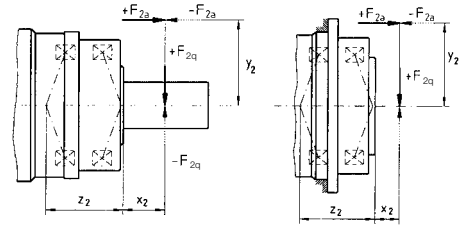

SP ⁺ /SPK ⁺ /SPC ⁺		060	075	100	140	180	210	240
z ₂	[mm]	42.2	44.8	50.5	63.0	79.2	94.0	99.0
	[in]	1.66	1.76	1.99	2.48	3.12	3.70	3.90
K _{1,2}	[Nm]	795	1109	1894	3854	9456	15554	19521
	[in.lb]	7036	9815	16762	34108	83686	137653	172761
p ₂		3.33	3.33	3.33	3.33	3.33	3.33	3.33

TP ⁺ /TPK ⁺ / TPC ⁺ /DP ⁺		004	010	025	050	110	300	500	2000	4000
z ₂	[mm]	57.6	82.7	94.5	81.2	106.8	140.6	157	216	283
	[in]	2.27	3.26	3.72	3.20	4.21	5.48	6.12	8.50	11.1
K _{1,2}	[Nm]	536	1325	1896	4048	9839	18895	27251	96400	184000
	[in.lb]	4744	11726	16780	35825	87075	167220	241171	853140	1628400
p ₂		3.33	3.33	3.33	3.33	3.33	3.33	3.33	3.33	3.33

HDP ⁺		010	025	050
z ₂	[mm]	90.4	99.1	83.5
	[in]	3.56	3.90	3.29
K _{1,2}	[Nm]	1325	1896	4048
	[in.lb]	11726	16780	35825
p ₂		3.33	3.33	3.33

TK⁺/SK⁺/HG⁺/SC⁺/VH⁺/VS⁺/VT⁺: Calculation using cymex®.
Please contact us for further information.

Hypoid gearboxes – Detailed sizing

Gearbox types and sizes			TK* 004 SK* 060 HG* 060	SPK* 075 TPK* 010 TPK* 025 MA	TK* 010 SK* 075 HG* 075	SPK* 100 TPK* 025 TPK* 050 MA
Dimensions of rearward drive						
Solid shaft:	diameter	$\varnothing D_{kg}$ mm	16	16	22	22
	length	L mm	28 ±0.15	28 ±0.15	36 ±0.15	36 ±0.15
Hollow shaft interface outer diameter		$\varnothing D_{hb}$ mm	18	18	24	24
Hollow shaft interface inner diameter		$\varnothing d_{hb}$ mm	15	15	20	20
Hollow shaft interface length		L_{hw} mm	14	14	16	16
Distance from input axis		A mm	42.9	42.9	52.6	52.6
Key dimensions (E = key as per DIN 6885, sheet 1, form A)	l	mm	25	25	32	32
	b_{hg}	mm	5	5	6	6
	a	mm	2	2	2	2
	h	mm	18	18	24.5	24.5
Output shaft threaded bore		B	M5x12.5	M5x12.5	M8x19	M8x19
Permissible load of rearward drive						
Max. acceleration torque ^{c)}	$T_{3a,zul}$	$= T_{2a,zul}$ on the condition that $T_{2b,fs} + T_{3b,fs} \leq T_{2a,zul}$	Please contact us	$= T_{2a,zul}$ on the condition that $T_{2b,fs} + T_{3b,fs} \leq T_{2a,zul}$	Please contact us	
Nominal output torque ^{c)}	T_{3N}	$= T_{2N} - T_{2n}$		$= T_{2N} - T_{2n}$		
EMERGENCY STOP torque ^{c)}	T_{3Not}	$= T_{2Not} - T_{2not}$		$= T_{2Not} - T_{2not}$		
Max. axial force ^{b)}	F_{3Amax}	1500	1500	1800	1800	
Max. lateral force ^{b)}	F_{3Qmax}	2300	2300	3000	3000	
Max. tilting torque	M_{3Kmax}	60	60	100	100	
Calculation of average tilting torque at the rearward drive						
Factor for tilting torque calculation	z_3 mm	11.9	11.9	15.6	15.6	
Distance between axial force and center of gearbox	y_3 mm	Application-dependent				
Distance between lateral force and shaft collar	x_3 mm	Application-dependent				

^{a)} Connection via shrink discs

^{b)} Refers to center of shaft

^{c)} See also page 336, "Detailed dimensioning – Gearbox"

Rearward drive:

Smooth shaft

Shaft with key

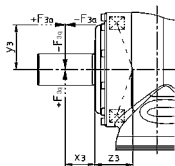

$$M_{3K} = F_{3a} \cdot y_3 + F_{3q} \cdot (x_3 + z_3)$$

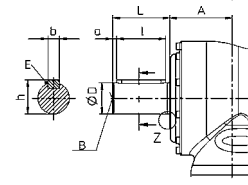
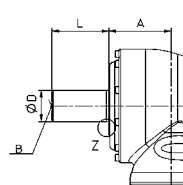

TK* 025 SK* 100 HG* 100	SPK* 140 TPK* 050 TPK* 110 MA	TK* 050 SK* 140 HG* 140	SPK* 180 SPK* 240 TPK* 110 TPK* 500 TPK* 300 MA	TK* 110 SK* 180 HG* 180	SPK* 210 TPK* 300 TPK* 500 MA
32	32	40	40	55	55
58 ±0.15	58 ±0.15	82 ±0.15	82 ±0.15	82 ±0.15	82 ±0.15
36	36	50	50	68	68
30	30	40	40	55	55
20	20	25	25	25	25
63.5	63.5	87	87	107.8	107.8
50	50	70	70	70	70
10	10	12	12	16	16
4	4	5	5	6	6
35	35	43	43	59	59
M12x28	M12x28	M16x36	M16x36	M20x42	M20x42
$= T_{2\alpha,zul}$ on the condition that $T_{2b,fs} + T_{3b,fs} \leq T_{2\alpha,zul}$	Please contact us	$= T_{2\alpha,zul}$ on the condition that $T_{2b,fs} + T_{3b,fs} \leq T_{2\alpha,zul}$	Please contact us	$= T_{2\alpha,zul}$ on the condition that $T_{2b,fs} + T_{3b,fs} \leq T_{2\alpha,zul}$	Please contact us
$= T_{2N} - T_{2n}$		$= T_{2N} - T_{2n}$		$= T_{2N} - T_{2n}$	
$= T_{2Not} - T_{2not}$		$= T_{2Not} - T_{2not}$		$= T_{2Not} - T_{2not}$	
2000	2000	9900	9900	4000	4000
3300	3300	9500	9500	11500	11500
150	150	580	580	745	745
16.5	16.5	20	20	23.75	23.75
Application-dependent					
Application-dependent					

Hollow shaft interface ^{a)}

Hollow shaft

Cover

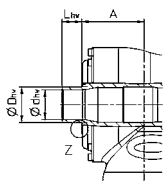

No connection possible

No connection possible

Worm gearboxes – Detailed sizing

A: Simplified sizing for servo motors based on the maximum motor torque: $M_{max} * i \leq T_{2\alpha}$

B: Sizing based on the application

Step 1:

Determine the application data

$$T_{2b} = \text{_____ [Nm]} \quad n_{1n} = \text{_____ [rpm]}$$

Step 2:

Determine the operating mode factor $K_M = \text{_____}$

Typical applications	Cycle	Torque characteristic	Operating mode factor K_M
Format changing, e.g. in packaging machines, drives for processing equipment, actuators etc.	S5 operation: Low duty cycle Small number of cycles Low dynamics		1.0
Tool changers with low dynamics, pick & place gantry axes, tire building machines etc.	S5 operation: Medium duty cycle Small number of cycles Medium dynamics		1.6
Linear axes in plasma, laser or water jet cutters, portals, tool changers with high dynamics	S5 operation: Medium duty cycle Medium number of cycles High dynamics		1.9
Roller drives in printing presses, star drives in rackers etc.	S1 operation: High duty cycle		2.2

cymex® 5 also allows sizing calculations for other applications / cycles!

Step 3:

Determine the sizing factor f_a with the operating mode factor K_M $f_a = \text{_____}$

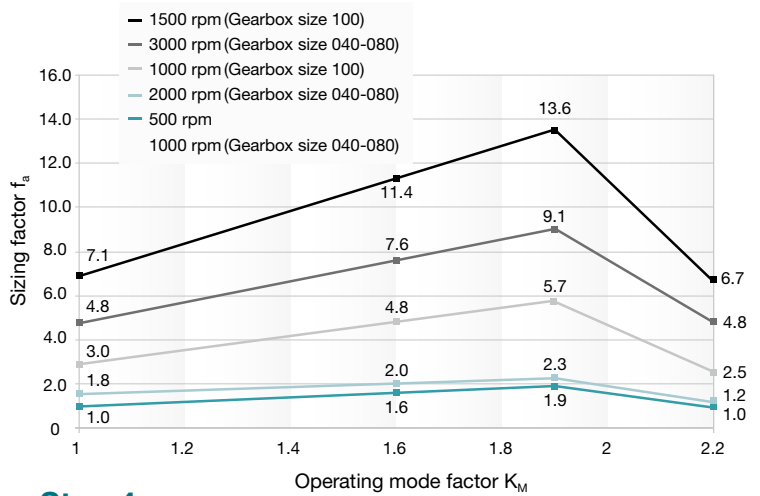

Step 4:

Compare the equivalent application torque with the maximum gearbox $T_{2\alpha}$ (see table, Step 5)

$$T_{2eq} = f_a * T_{2b} \leq T_{2\alpha}$$

$$T_{2eq} = \text{_____} * \text{_____} \leq T_{2\alpha}$$

$$T_{2eq} = \text{_____ [Nm]} \leq \text{_____ [Nm]}$$

We recommend using a vent screw for duty cycles $\geq 60\%$, longer than 20 min (S1 operation) and $n_{1N} \geq 3000$ rpm.

Step 5: Quick selection of the technical data

			V-Drive Advanced				
			040	050	063	080	100
Ratio	i		4 - 400				
Maximum torque ^{a)} (at $n_1 = 500$ rpm)	$T_{2\alpha}$	Nm	74-106	165-204	319-372	578-785	1184-1505
		in.lb	655-938	1460-1805	2823-3292	5115-6947	10478-13319
Max. input speed	n_{1max}	rpm	6000	6000	4500	4000 / 4500 ^{b)}	3500 / 4000 ^{b)}
Max. lateral force	$F_{2\alpha Max}$	N	2400	3800	6000	9000	14000
		lb _f	540	855	1350	2025	3150
Operating noise (with $n_1 = 3000$ rpm no load)	L_{PA}	dB(A)	≤ 54	≤ 62	≤ 64	≤ 66	≤ 70
Max. torsional backlash	j_t	arcmin	≤ 3	≤ 3	≤ 3	≤ 3	≤ 3
Service life (For calculation see "Information")	L_h	h	> 20000	> 20000	> 20000	> 20000	> 20000

^{a)} The maximum torques depend on the ratio.

^{b)} First value for single-stage version, second value for two-stage version.

Account must be taken of the lateral and axial forces at the output:

Please also carry out steps 6 and 7 if forces are present at the output (e.g. if timing belt pulleys, pinions or levers are mounted there).

Step 6 (if external forces are present):

Determine the forces acting on the output and check the boundary conditions

- Lateral force $F_{2q} = \underline{\hspace{2cm}}$ [N]
- Lateral force distance $x_2 = \underline{\hspace{2cm}}$ [mm]
- Axial force $F_{2a} = \underline{\hspace{2cm}}$ [N]
- Axial force distance $y_2 = \underline{\hspace{2cm}}$ [mm]
- (required if F_{2a} is present)

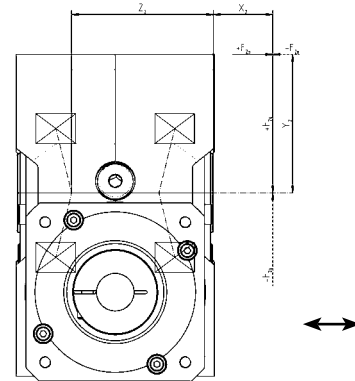

Conditions if axial force F_{2a} is present:

- 1. $F_{2a} \leq 0.25 * F_{2q} \Rightarrow (\underline{\hspace{2cm}} \leq 0.25 * \underline{\hspace{2cm}})$ Met Not met: Sizing with cymex® 5
- 2. $y_2 \leq x_2 \Rightarrow (\underline{\hspace{2cm}} \leq \underline{\hspace{2cm}})$ Met Not met: Sizing with cymex® 5

Step 7:

Determine the maximum equivalent force acting on the output $F_{2,eq}$

$F_{2,eq} = F_{2q} + 0.25 * F_{2a} \leq F_{2QMax}$ (F_{2QMax} can be determined from the diagram below)

$F_{2,eq} = \underline{\hspace{2cm}} + 0.25 * \underline{\hspace{2cm}} \leq \underline{\hspace{2cm}}$

$F_{2,eq} = \underline{\hspace{2cm}}$ [N] \leq $\underline{\hspace{2cm}}$ [N] Met Not met: Sizing with cymex® 5

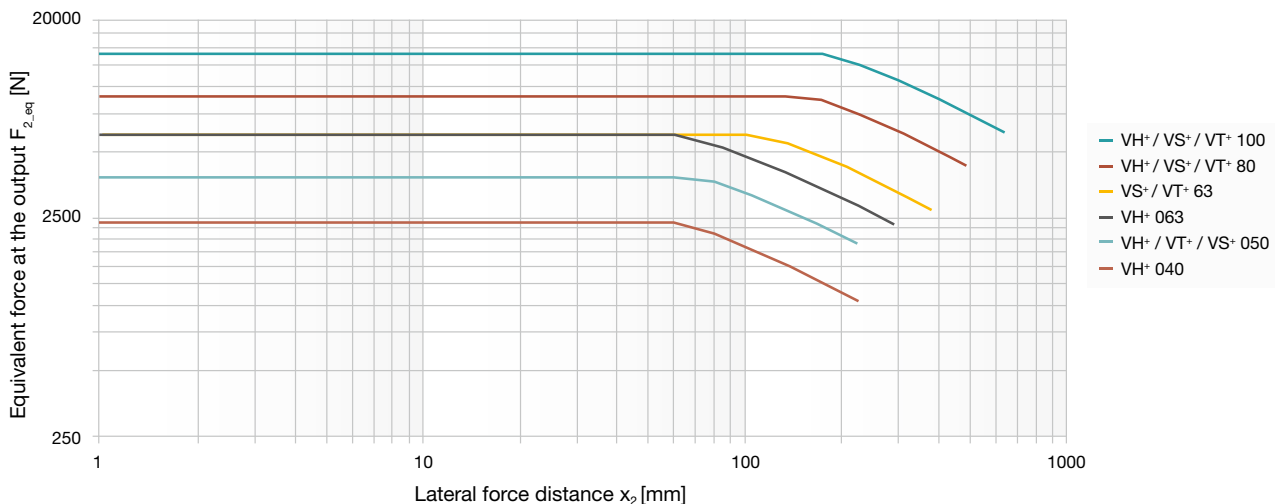

Glossary – the alphabet

Adapter plate

WITTENSTEIN alpha uses a system of standardized adapter plates to connect the motor and the gearbox, making it possible to mount a WITTENSTEIN alpha gearbox to any desired motor without difficulty.

Angular minute

A degree is subdivided into 60 angular minutes (= 60 arcmin = 60').

Example:

If the torsional backlash is $j_t = 1$ arcmin, the output can be turned $1/60^\circ$. The repercussions for the application are determined by the arc length:

$$b = 2 \cdot \pi \cdot r \cdot \alpha^\circ / 360^\circ$$

Example:

A pinion with a radius $r = 50$ mm mounted on a gearbox with torsional backlash $j_t = 3$ arcmin can be turned $b = 0.04$ mm.

Axial force (F_{2AMax})

The axial force acting on a gearbox runs parallel to its output shaft or perpendicular to its output shaft. It may be applied with axial offset via a lever arm y_2 under certain circumstances, in which case it also generates a bending moment. If the axial force exceeds the permissible catalog values (max. axial force F_{2AMax}), additional design features (e.g. axial bearings) must be implemented to absorb these forces.

Example with output shaft and flange:

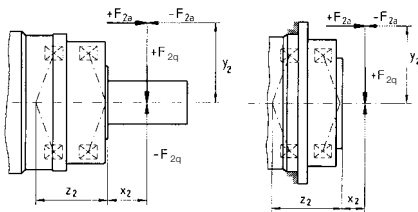

Bushing

If the motor shaft diameter is smaller than the → **clamping hub**, a bushing is used to compensate the difference in diameter. The bushing must have a minimum thickness of 1 mm and a motor shaft diameter of 2 mm.

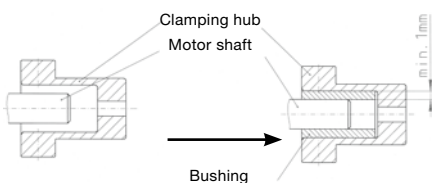

CAD POINT

Performance data, dimension sheets and CAD data for all types of gearbox can be found online in our CAD POINT together with comprehensive documentation of the selection. (www.wittenstein-cad-point.com)

Clamping hub

The clamping hub ensures a frictional connection between the motor shaft and gearbox. A → **bushing** is used as the connecting element if the motor shaft diameter is smaller than that of the clamping hub. Optionally, a positive connection via a parallel key is also possible.

Continuous operation (S1)

Continuous operation is defined by the → **duty cycle**. If the duty cycle is greater than 60 % and / or longer than 20 minutes, this qualifies as continuous operation. → **Operating modes**

Cyclic operation (S5)

Cyclic operation is defined via the → **duty cycle**. If the duty cycle is less than 60 % and shorter than 20 minutes, it qualifies as cyclic operation (→ **operating modes**).

cymex®

cymex® is the calculation software developed by our company for dimensioning complete drive trains. The software enables the precise simulation of motion and load variables. The software is available for download from our website (www.wittenstein-cymex.com). We can also provide training to enable you to make full use of all the possibilities provided by the software.

Degree of protection (IP)

The various degrees of protection are defined in DIN EN 60529 "Degrees of protection offered by enclosure (IP code)". The IP degree of protection (International Protection) is represented by two digits. The first digit indicates the protection against the ingress of impurities and the second the protection against the ingress of water.

Example:

IP65

Protection against the ingress of dust (dust-proof)

Protection against spray water

Duty cycle (DC)

The cycle determines the duty cycle DC. The times for acceleration (t_b), constant travel if applicable (t_c) and deceleration (t_d) combined yield the duty cycle in minutes. The duty cycle is expressed as a percentage with inclusion of the pause time t_e .

$$DC [\%] = \frac{t_b + t_c + t_d}{t_b + t_c + t_d + t_e} \cdot 100 \frac{\text{Motion duration}}{\text{Cycle duration}}$$

$$DC [\text{min}] = t_b + t_c + t_d$$

Emergency stop torque (T_{2Not})

The Emergency stop torque T_{2Not} is the maximum permissible torque at the gearbox output and must not be reached more than 1000 times during the life of the gearbox. It must never be exceeded!

Efficiency (η)

Efficiency [%] η is the ratio of output power to input power. Power lost through friction reduces efficiency to less than 1 or 100 %.

$$\eta = P_{\text{off}} / P_{\text{on}} = (P_{\text{on}} - P_{\text{loss}}) / P_{\text{on}}$$

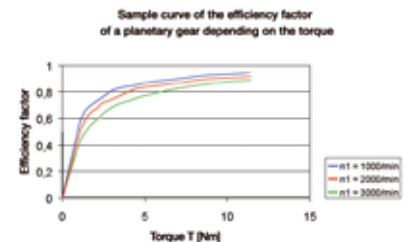

WITTENSTEIN alpha always measures the efficiency of a gearbox during operation at full load. If the input power or torque are lower, the efficiency rating is also lower due to the constant no-load torque. Power losses do not increase as a result. A lower efficiency is also expected at high speeds (see illustration).



Ex symbol

Devices bearing the Ex symbol comply with EU Directive 94 / 9 / EC (ATEX) and are approved for use in defined explosion-hazardous zones.

Detailed information on explosion groups and categories, as well as further information on the relevant gearbox are available upon request.

Food-grade lubrication (F)

These products are designed with food-grade lubrication and can therefore be used in the food industry. Note the reduced torques compared to the standard products. (V-Drive excluded). The exact torques can be found in cymex® 5 or CAD POINT.

HIGH SPEED (MC)

The HIGH SPEED version of our gearbox has been specially developed for applications in continuous operation at high input speeds, e.g. as found in the printing and packaging industries.

HIGH TORQUE (MA)

WITTENSTEIN alpha gearboxes are also available in a HIGH TORQUE version. These gearboxes are particularly suited to applications requiring extremely high torques and maximum stiffness.

Hysteresis curve

The hysteresis is measured to determine the torsional rigidity of a gearbox. The result of this measurement is known as the hysteresis curve.

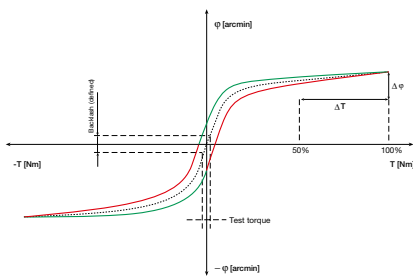

If the input shaft is locked, the gearbox is continuously loaded and relieved at the output in both directions up to a defined torque. The torsional angle is plotted against the torque. This yields a closed curve from which the → **torsional backlash** and → **torsional rigidity** can be calculated.

Jerk (j)

Jerk is derived from acceleration and is defined as the change in acceleration within a unit of time. The term impact is used if the acceleration curve changes abruptly and the jerk is infinitely large.

Lateral force ($F_{2QM_{max}}$)

The max. lateral force $F_{2QM_{max}}$ [N] is the force component acting at right angles to the output shaft or parallel to the output flange. It acts perpendicular to the → axial force and can assume an axial distance of x_2 in relation to the shaft nut or shaft flange, which acts as a lever arm. The lateral force produces a bending moment (see also → axial force).

Mass inertia ratio ($\lambda = \text{Lambda}$)

The mass inertia ratio λ is the ratio of external inertia (application side) to internal inertia (motor and gearbox side). It is an important parameter determining the controllability of an application. Accurate control of dynamic processes becomes more difficult with differing mass moments of inertia and as λ becomes greater. WITTENSTEIN alpha recommends that a guideline value of $\lambda < 5$ is maintained. A gearbox reduces the external mass moment of inertia by a factor of $1/i^2$.

$$\lambda = \frac{J_{\text{extern}}}{J_{\text{intern}}}$$

J reduced externally at input:

$$J'_{\text{external}} = J_{\text{external}} / i^2$$

Simple applications ≤ 10

Dynamic applications ≤ 5

Highly dynamic applications ≤ 1

Mass moment of inertia (J)

The mass moment of inertia J [kg/cm²] is a measurement of the effort applied by an object to maintain its momentary condition (at rest or moving).

Mesh frequency (f_z)

The mesh frequency may cause problems regarding vibrations in an application, especially if the excitation frequency corresponds to an intrinsic frequency of the application. The mesh frequency can be calculated for planetary gearboxes from WITTENSTEIN alpha (exception: gearboxes with ratio $i = 8$) using the formula $f_z = 1.8 \cdot n_2$ [rpm] and on planetary gearboxes from WITTENSTEIN alpha, is independent of the ratio. If it does indeed become problematic, the intrinsic frequency of the system can be changed or another gearbox (e.g. hypoid gearbox) with a different mesh frequency can be selected.

No-load running torque (T_{012})

The no-load running torque T_{012} is the torque which must be applied to a gearbox in order to overcome the internal friction; it is therefore considered lost torque. The values specified in the catalog are calculated by WITTENSTEIN alpha at a speed of $n_1 = 3000$ rpm and an ambient temperature of 20 °C.

T_{012} :	0	1 → 2
	without load	from input side towards output side

Idling torques decrease during operation.

NSF

Lubricants certified as grade H1 by the NSF (National Sanitation Foundation) can be used in the food sector where occasional unavoidable contact with food cannot be excluded.

Operating modes

(continuous operation **S1** and cyclic operation **S5**)

Gearboxes are selected depending on whether the motion profile is characterized by frequent acceleration and deceleration phases in → **cyclic operation** (S5) as well as pauses, or whether it is designed for → **continuous operation** (S1), i.e. with long phases of constant motion.

Operating noise (L_{PA})

The gear ratio and speed affect the noise level. As a general rule: A higher speed means a higher noise level, while a higher ratio means a lower noise level. The values specified in our catalog are based on a reference ratio and speed. The reference speed is either $n_1 = 3000$ rpm or $n_1 = 2000$ rpm depending on the size of the gearbox. You can find ratio-specific values in cymex® – www.wittenstein-cymex.com.

Output shaft revolution (f_a)

Factor f_a determines the number of life time cycles for the required gearbox service life. It describes the number of revolutions at the output used to assess the torque permitted at the output.

→ Refer to this term for further details.

Glossary – the **alphabet**

Positioning accuracy

The positioning accuracy is determined by the angular deviation from a setpoint and equals the sum of the torsional angles due to load → **(torsional rigidity and torsional backlash)** and kinetics → **(synchronization error) occurring simultaneously in practise** .

Quality control

All Premium and Advanced gearboxes are subject to a final inspection before they leave the WITTENSTEIN alpha factory to ensure that they are all delivered within specification.

Ratio (i)

The gear ratio i indicates the factor by which the gearbox transforms the three relevant parameters of motion (speed, torque and mass moment of inertia). The factor is a result of the geometry of the gearing elements (Example: $i = 10$).

$$\begin{array}{l}
 n_1 = 3000 \text{ min}^{-1} \quad \begin{array}{l} \nearrow :i \\ \searrow \cdot i \end{array} \quad \begin{array}{l} T_2 = 200 \text{ Nm} \\ n_2 = 300 \text{ min}^{-1} \end{array} \\
 T_1 = 20 \text{ Nm} \\
 J_1 = 0,10 \text{ kgm}^2 \quad \longleftarrow \quad J_2 = 10 \text{ kgm}^2 \quad \text{(Application)}
 \end{array}$$

Safety note

For applications with special safety requirements (e.g. vertical axes, clamped drives), we recommend exclusive use of our Premium and Advanced products (excluding V-Drive).

SIZING ASSISTANT

The online SIZING ASSISTANT from WITTENSTEIN alpha allows the efficient selection of a gearbox in seconds. You can use various motor or application entry options to select the right gearbox for your application in seconds (www.sizing-assistant.com).

Speed (n)

Two speeds are of relevance when dimensioning a gearbox: the maximum speed and the thermal speed limit at the input. The maximum permissible speed n_{1Max} must not be exceeded because it serves as the basis for dimensioning → **cyclic operation**. The nominal speed n_{1N} must not be exceeded in → **continuous operation**. The thermal speed limit n_{1T} at an ambient temperature of 20° C, is determined by the maximum

gearbox temperature of $T = 90^\circ \text{ C}$ at no-load. As can be seen in the diagram below, the temperature limit is reached more quickly in the presence of an elevated outside temperature. In other words: the nominal input speed must be reduced if the ambient temperature is high. The values applicable to your gearbox are available from WITTENSTEIN alpha on request.

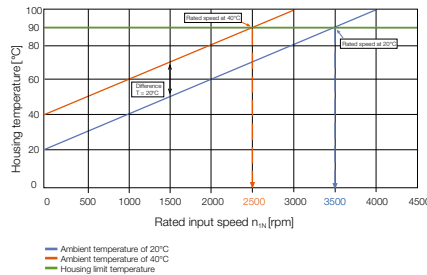

Delivery of speedline®

If necessary, you can receive delivery of standard series in 24 or 48 hours ex works. Outstanding flexibility for fast deliveries at short notice

Synchronization

Synchronization refers to the measurable speed variation between the input and output during one revolution of the output shaft. It is caused by manufacturing tolerances and causes minute angular deviations and ratio fluctuations.

Technical data

You can download further technical data relating to the entire product portfolio from our website

Tilting rigidity

The tilting rigidity C_{2K} [Nm/arcmin] of the gearbox consists of the bending stiffness of the output or pinion shaft and the stiffness of the output bearing. It is defined as the quotient of tilting moment M_{2K} [Nm] and tilting angle Φ [arcmin]

$$C_{2K} = M_{2K} / \Phi.$$

Tilting torque (M_{2K})

The tilting torque M_{2K} is a result of the → **axial and lateral forces** applied and their respective points of application in relation to the inner radial bearing on the output side.

Torsional backlash (j_t)

Torsional backlash j_t [arcmin] is the maximum angle of torsion of the output shaft in relation to the input. Simply put, the torsional backlash represents the gap between two tooth flanks.

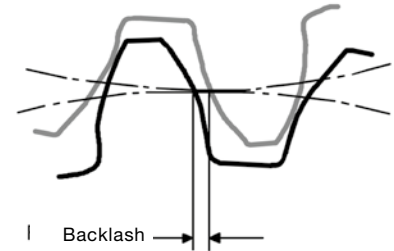

Torsional backlash is measured with the input shaft locked.

The output is then loaded with a defined test torque in order to overcome the internal gearbox friction. The main factor affecting torsional backlash is the face clearance between the gear teeth. The low torsional backlash of WITTENSTEIN alpha gearboxes is due to their high manufacturing accuracy and the specific combination of gear wheels.

Torsional rigidity (C_{t21})

Torsional rigidity [Nm/arcmin] C_{t21} is defined as the quotient of applied torque and resulting torsion angle ($C_{t21} = \Delta T / \Delta \Phi$). It shows the torque required to turn the output shaft by one angular minute. The torsional rigidity can be determined from the → **hysteresis curve**.

Torsional rigidity C , angle of torsion Φ

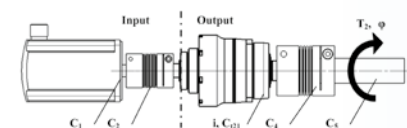

Reduce all torsional rigidity values at the output:

$$C_{(n),out} = C_{(n),in} * i^2$$

with i = Gearbox ratio [-]

$C_{(n)}$ = Individual rigidity values [Nm/arcmin]

→ Refer to this term for further details.

Note: The torsional rigidity C_{t21} for the gearbox always relates to the output.

Series connection of torsional rigidity values

$$1/C_{\text{tot}} = 1/C_{1,\text{out}} + 1/C_{2,\text{out}} + \dots + 1/C_{(n)}$$

Angle of torsion Φ [arcmin]

$$\Phi = T_2 * 1/C_{\text{tot}}$$

with T_2 = output torque [Nm]

Torque (M)

The torque is the actual driving force of a rotary motion. The force and lever arm combine to produce the torque that acts around the axis of rotation. $M = F \cdot l$

Torque ($T_{2\alpha}$)

$T_{2\alpha}$ represents the maximum torque transmitted by the gearbox. This value may decrease depending on the application-specific conditions and the precise evaluation of the movement profile.



Glossary – Formulae

Formulae

Torque [Nm]	$T = J \cdot \alpha$	J = Mass moment of inertia [kgm ²] α = Angular acceleration [1/s ²]
Torque [Nm]	$T = F \cdot l$	F = Force [N] l = Lever, length [m]
Acceleration force [N]	$F_b = m \cdot a$	m = Mass [kg] a = Linear acceleration [m/s ²]
Frictional force [N]	$F_{\text{Reib}} = m \cdot g \cdot \mu$	g = Acceleration due to gravity 9.81 m/s ² μ = Coefficient of friction
Angular speed [1/s]	$\omega = 2 \cdot \pi \cdot n / 60$	n = Speed [rpm] π = PI = 3.14...
Linear speed [m/s]	$v = \omega \cdot r$	v = Linear speed [m/s] r = Radius [m]
Linear speed [m/s] (spindle)	$v_{\text{sp}} = \omega \cdot h / (2 \cdot \pi)$	h = Screw pitch [m]
Linear acceleration [m/s²]	$a = v / t_b$	t_b = Acceleration time [s]
Angular acceleration [1/s²]	$\alpha = \omega / t_b$	
Pinion path [mm]	$s = m_n \cdot z \cdot \pi / \cos \beta$	m_n = Normal module [mm] z = Number of teeth [-] β = Helix angle [°]

Conversion table

1 mm	= 0.039 in
1 Nm	= 8.85 in.lb
1 kgcm²	= 8.85 x 10 ⁻⁴ in.lb.s ²
1 N	= 0.225 lb _f
1 kg	= 2.21 lb _m

Symbol

Symbol	Unit	Designation
C	Nm/arcmin	Stiffness
ED	%, min	Duty cycle
F	N	Force
f_s	–	Load factor
f_e	–	Factor for duty cycle
i	–	Ratio
j	arcmin	Backlash
J	kgm ²	Mass moment of inertia
$K1$	Nm	Factor for bearing calculation
L	h	Service life
L_{PA}	dB(A)	Operating noise
m	kg	Mass
M	Nm	Torque
n	rpm	Speed
p	–	Exponent for bearing calculation
η	%	Efficiency
t	s	Time
T	Nm	Torque
v	m/min	Linear speed
z	1/h	Number of cycles

Index

Index	Designation
Capital letter	Permissible values
Small letter	Actual values
1	Input
2	Output
A/a	Axial
B/b	Acceleration
c	Constant
d	Deceleration
e	Pause
h	Hours
K/k	Tilting
m	Mean
Max/max	Maximum
Mot	Motor
N	Nominal
Not/not	Emergency stop
0	No load
Q/q	Lateral
t	Torsional
T	Tangential

Ordering code – Planetary gearbox

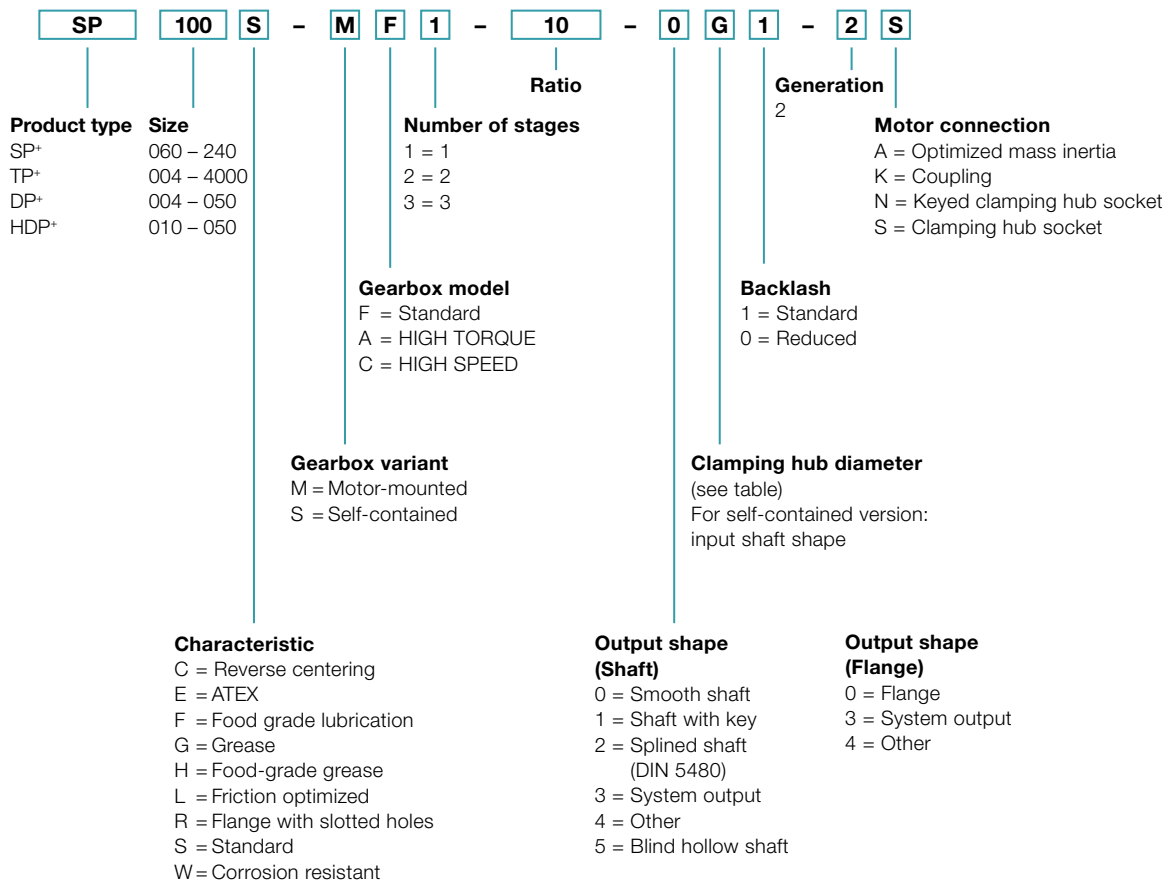

Mounting positions and clamping hub diameters

Clamping hub diameter
(see technical data sheet for possible diameters)

B5
Horizontal

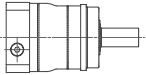

V1
Output vertical downwards

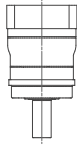

V3
Output vertical upwards

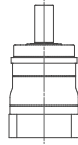

S
Can be tilted $\pm 90^\circ$
from a horizontal position

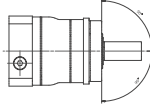

Code letter	mm	Code letter	mm
B	11	I	32
C	14	K	38
E	19	M	48
G	24	N	55
H	28	O	60

Intermediate sizes possible using bushings with a minimum thickness of 1 mm.

For information purposes only – not required when placing orders!

Exceptions:

- The mounting position of TP+ 2000 / 4000 must be specified.
- DP+ / HDP+ products are designed for mounting position B5 as standard!

If the mounting position is different, contact WITTENSTEIN alpha without fail.

Ordering code – Hypoid- / Bevel gearboxes

SPK⁺ 100 S - M F 2 - 50 - 0 E 1 - 1 K 0 1

<p>Product type</p> <p>SK⁺ 060 – 180 SPK⁺ 075 – 240 SC⁺ 060 – 180 SPC⁺ 060 – 180 HG⁺ 060 – 180 TK⁺ 004 – 110 TPK⁺ 010 – 4000 TPC⁺ 004 – 180</p>	<p>Size</p> <p>060 – 180 075 – 240 060 – 180 060 – 180 060 – 180 004 – 110 010 – 4000 004 – 180</p>	<p>Ratio</p> <p>50</p>	<p>Number of stages</p> <p>1 = 1 2 = 2 3 = 3 4 = 4</p>	<p>Generation</p> <p>1</p>	<p>Number of output stages</p> <p>0 = 0 1 = 1 2 = 2</p>	<p>Backlash</p> <p>1 = Standard 0 = Reduced</p>	<p>Number of input stages</p> <p>0 = 0 1 = 1</p>	<p>Gearbox variant</p> <p>M = Motor-mounted</p>	<p>Clamping hub diameter</p> <p>(see table)</p>	<p>Motor connection</p> <p>K = Coupling S = Clamping hub socket</p>	<p>Characteristic</p> <p>B = Modular output combination E = ATEX F = Food grade lubrication S = Standard W = Corrosion resistant</p>	<p>Output shape (Shaft)</p> <p>0 = Smooth shaft 1 = Shaft with key 2 = Splined shaft (DIN 5480) 3 = System output 4 = Other 5 = Blind hollow shaft</p>	<p>Output shape (Flange)</p> <p>0 = Flange 3 = System output 4 = Other 5 = Flanged hollow shaft</p>	<p>Output shape (Hollow shaft)</p> <p>5 = Hollow shaft interface / Hollow shaft 6 = Hollow shaft interface / Hollow shaft interface</p>
---	---	-------------------------------	--	-----------------------------------	--	---	--	--	--	---	---	--	---	---

Mounting positions

B5 / V3
Output horizontal/
motor shaft vertical upwards



B5 / V1
Output horizontal/
motor shaft vertical downwards

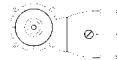

V1 / B5
Output vertical downwards/
motor shaft horizontal



V3 / B5
Output vertical upwards/
motor shaft horizontal

B5 / B5
Output horizontal/
motor shaft horizontal

Please note the orientation when placing your order.

Exceptions:

- The mounting position of TPK⁺ 2000 / 4000 must be specified.
- If the mounting position is different, contact WITTENSTEIN alpha without fail.

Characteristic: Modular output combination (B)

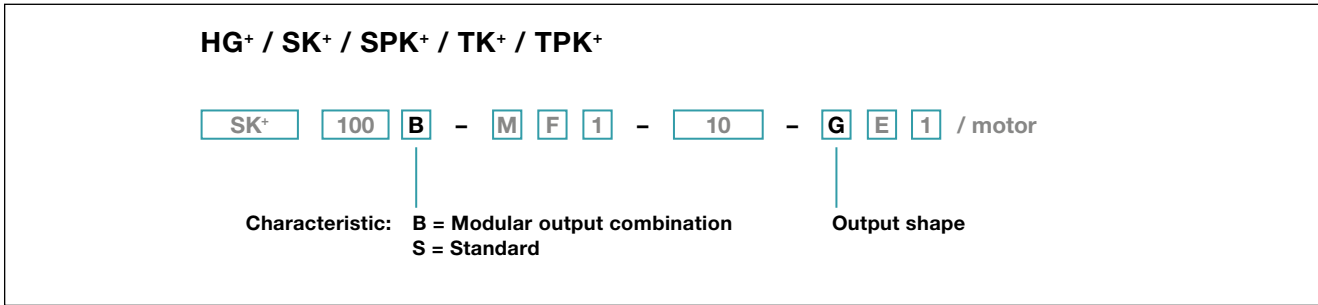

When selecting an output combination from the modular system, please select the letter „B“ as the characteristic in the ordering code. The digit for the required output shape is the modular matrix system.

Example: If you opt for an SK+ with a smooth shaft and require an additional output in the form of a shaft with key, then select the letter „G“ and enter in the order key under „Output shape“.

		Backward					
		Output shape					
Front							
		Smooth shaft	Shaft with key	Hollow shaft interface	Hollow shaft	Cover	
SK+ / SPK+	 Smooth shaft	D	G	A	-	0*	
	 Shaft with key	E	H	B	-	1*	
	 Splined shaft (DIN 5480)	F	I	C	-	2*	
SPK+	 Blind hollow shaft	O	P	N	-	5*	
TK+	 Flanged hollow shaft	D	G	6	5*	0	
TPK+	 Flange	D	G	6	-	0*	
HG+	 Hollow shaft	D	G	6*	5*	0	

* Standard version: please specify characteristic „S“ in the order code

Ordering code – Worm gearboxes

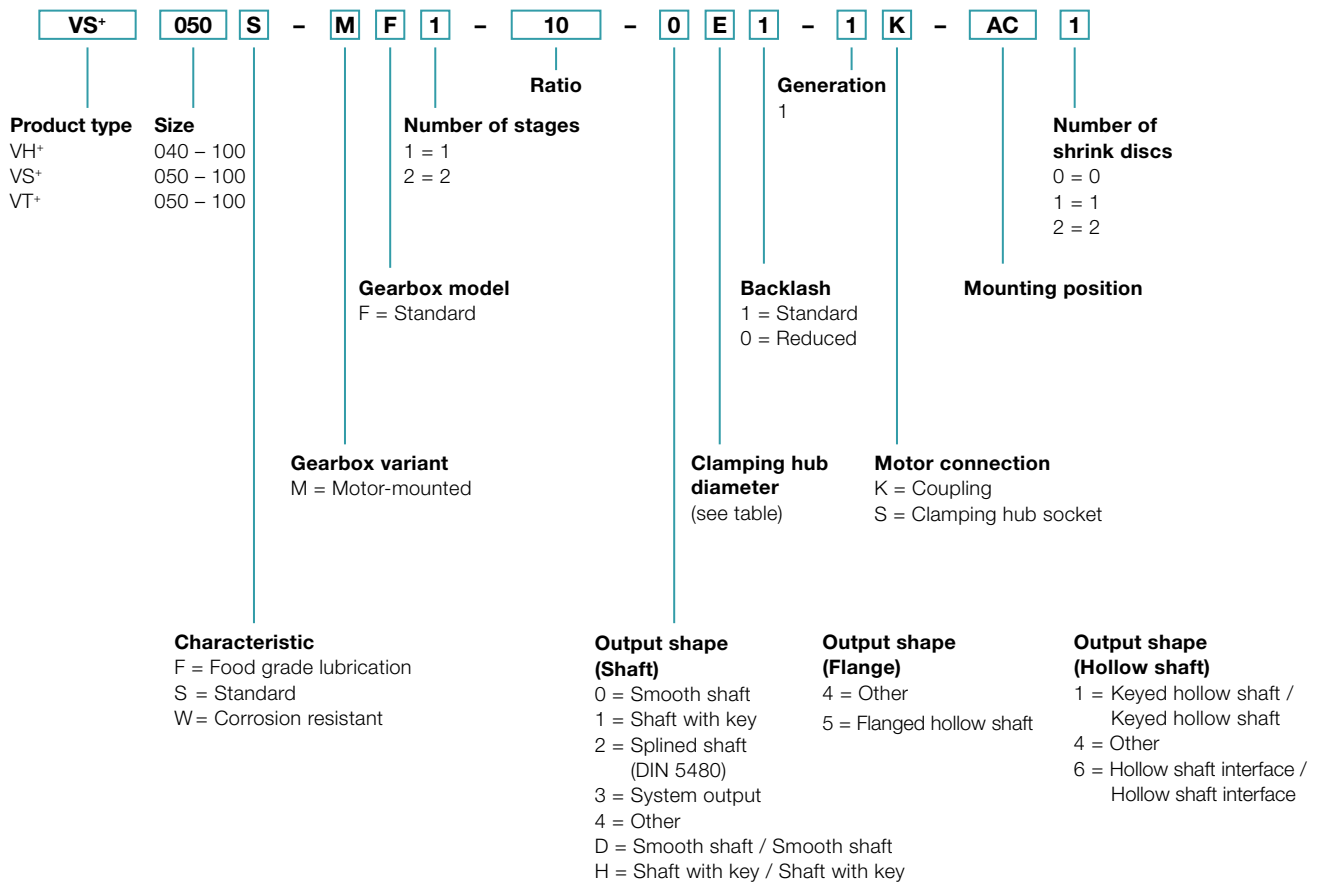

Mounting positions and clamping hub diameters

Mounting position (only relevant for oil volume)

Output side A:
View of motor interface,
Output left
Only valid for VS⁺, VT⁺

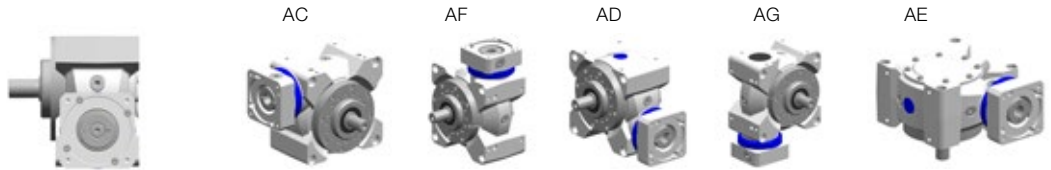

Output side B:
View of motor interface,
Output right
Only valid for VS⁺, VT⁺

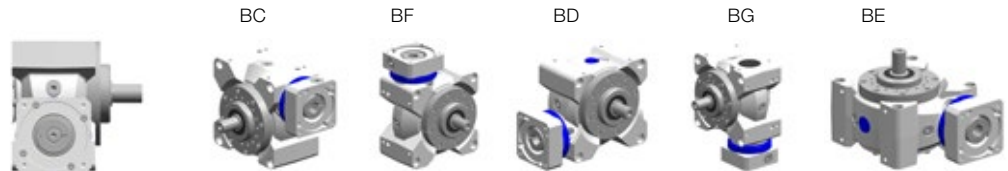

For VH⁺ and VS⁺ with dual-shaft output or hollow shaft, A and B in the mounting position must be replaced with 0 (zero).

Clamping hub diameter

(see technical data sheet for possible diameters)

Code letter	mm	Code letter	mm
B	11	I	32
C	14	K	38
E	19	M	48
G	24	N	55
H	28	O	60

Intermediate diameters possible in combination with a bushing with a minimum thickness of 1 mm.

YOUR NOTE

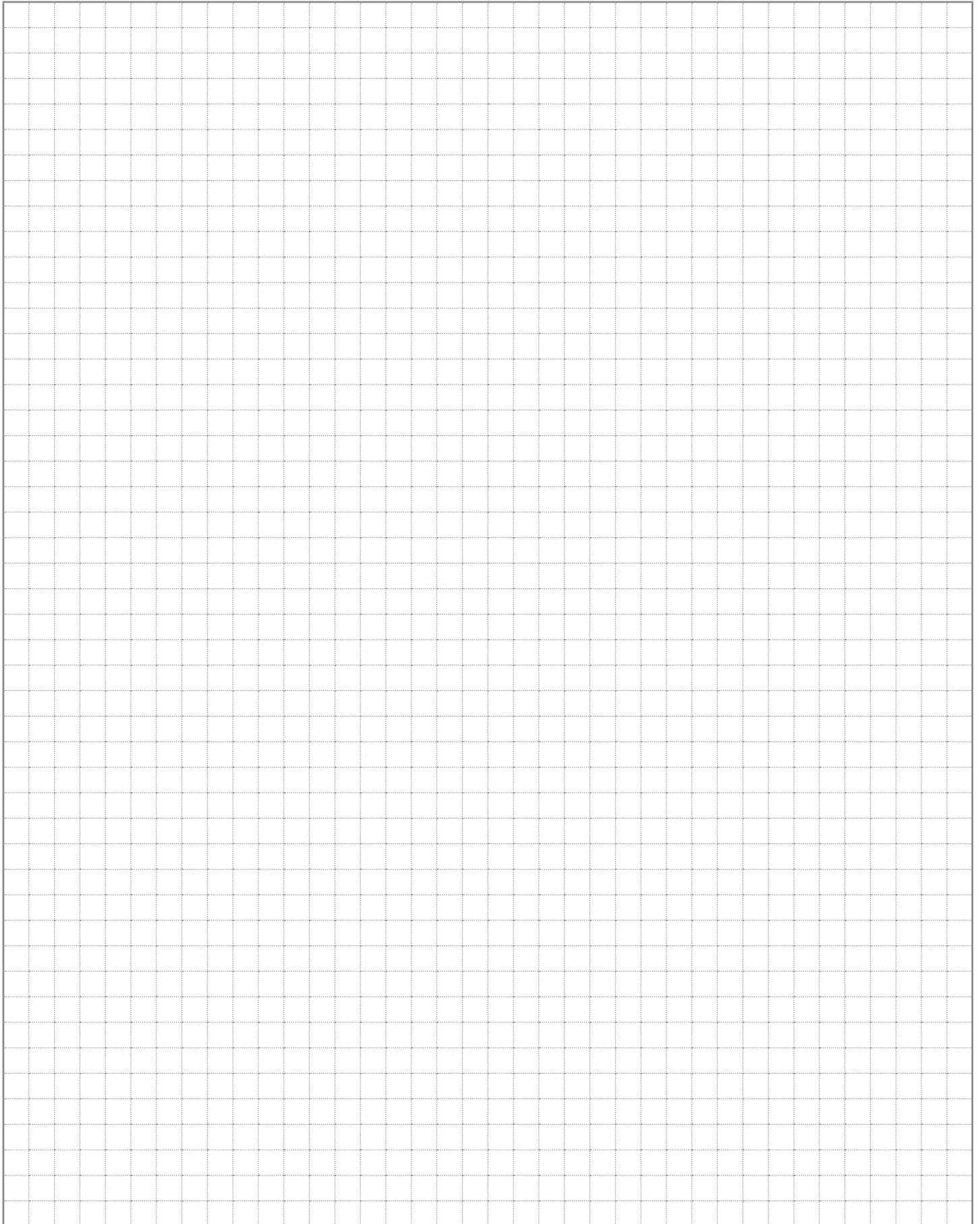

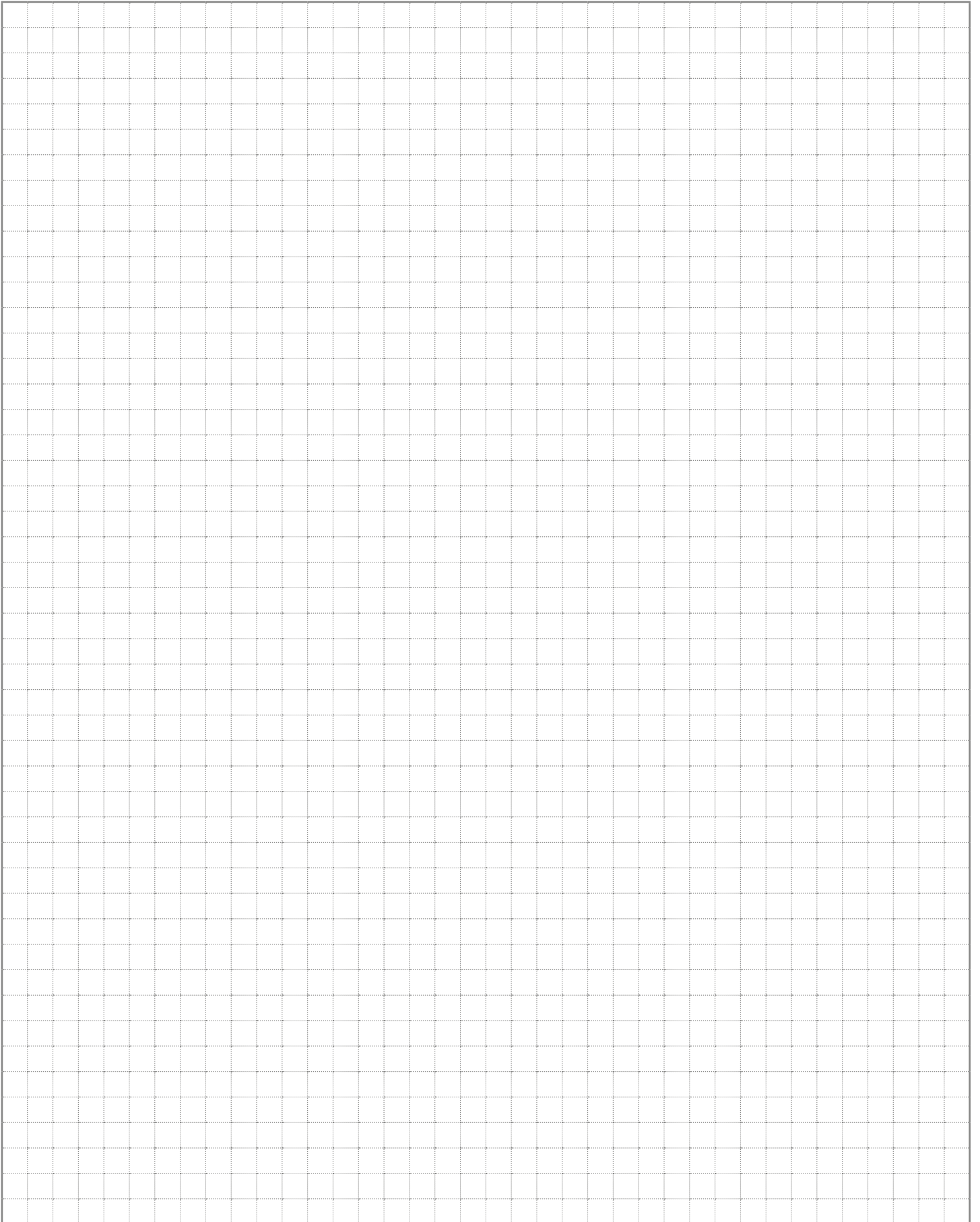



alpha

WITTENSTEIN alpha GmbH
Walter-Wittenstein-Straße 1
97999 Igersheim
Germany

Tel. +49 7931 493-0
24h-Service-Hotline: Tel. +49 7931 493-12900
speedline®: Tel. +49 7931 493-10444
info@wittenstein-alpha.com

Subject to technical changes. alpha Advanced Line

WITTENSTEIN alpha – Intelligent drive systems

www.wittenstein-alpha.com

The entire world of drive technology – Catalogs available on request or online at www.wittenstein-alpha.com/catalogs



alpha Advanced Line. Maximum power density and outstanding positioning accuracy for complex applications.



alpha Basic / Value Line. Reliable, flexible and economical solutions for a wide range of applications.



alpha Linear Systems. Precise, dynamic system solutions for every requirement.



alpha Mechatronic Systems. Energy-efficient, versatile and flexible mechatronic drive systems.